



ABB motors
Low voltage general performance motors
for hazardous area



The Leader in Motors

ABB is a global engineering and technology group serving customers in electrical power generation; transmission and distribution; automation; oil, gas and petrochemicals; industrial products and contracting; and financial services. The product range includes a full range of industrial electric motors, both AC and DC, LV and HV meeting the needs of most application, with virtually any power rating.

Within the Group, ABB Motors is the world's leading manufacturer of low-voltage induction motors, having over 100 years experience and a presence in more than 100 countries. ABB Motors's broad understanding of customer applications enables it to work closely to solve individual problems or to supply custom-designed motors for any project-no matter how demanding.

For customers, this all represents a solid value and commitment revealed in the dependable quality of ABB Motor's products and in its unrivalled customer service and back up. The hallmarks of its product are efficiency, robustness and reliability, combined to represent the best value available. Customers the world over rely on ABB Motors as the most solid and reliable supplier of electric motors. But above all, ABB Motors values its customers.

The best value is also enhanced by ABB Motors's worldwide customer service network guaranteeing fast delivery, rapid response and local back-up, as well as by worldwide ABB Service network supporting the after sales service.

ABB Motors has manufacturing facilities in Finland, Italy, Spain, Sweden, China and India. The comprehensive Motor stocks at each of these sites are reinforced by large and versatile stocks at Central Stock Nordic in Vasteras, Sweden; Central Stock, Europe in Menden, Germany and Central Stock Asia in Singapore, and by numerous distribution stocks.



Making you more competitive

ABB has been manufacturing motors for over 100 years. Our products are designed to be reliable, efficient and cost effective, and we can supply motors for practically any application. A full range of services is available through our worldwide service organization, with the latest eBusiness systems providing round-the-clock access, easy ordering and fast delivery.

M2000 motors

Our M2000 range offers quality motors, providing you with the ideal efficiency level for your needs. And our 24-hour availability helps make your life easier. Through our extended support and services such as eBusiness solutions and an efficient global stock concept, we provide you with easy ordering and quick delivery.



Industrial

As a key element of its business strategy, ABB has committed to a broad program of product development and positioning under the Industrial^{IT} umbrella. This initiative is geared towards increasing integration of ABB products as the "building blocks" of larger solutions, while incorporating functionality that will allow multiple products to interact seamlessly as components of real-time automation and information systems.

Motors and generators represent one of the fundamental building blocks in the Industrial^{IT} architecture.

ABB (www.abb.com) is a leader in power and automation technologies that enable utility and industry customers to improve performance while lowering environmental impacts. The ABB Group of companies operates in around 100 countries and employs about 107,000 peoples.

ATEX Directives 94/9/EC (“95”) and 1999/92/EC (“137”)

ATEX Directives harmonize the safety rules in respect with the free trading principles of the European Community.

The responsibilities are split in two areas between the manufacturers and the end users. The manufacturers have to comply with the ‘Essential Health and Safety Requirements’ of the Products Directive 94/9/EC, or ATEX 95; and the end users must proceed to make an Explosion Protection Document based on risks assessment of their ‘work places’ and ‘work equipment’ to fulfil the ‘minimum requirements’ listed in the Worker Protection Directive 1999/92/EC or ATEX 137.

Motors comply fully with the ATEX product directive 94/9/EC. According to the regulations, low voltage motors for hazardous areas are exempted from the Low Voltage Directive, the EMC directive as well as the Machinery Directive.

IEC and the corresponding EN Standards are at the moment in a new process of renewal or revision. In general old and new standard or revision are both in parallel valid for about 3 years. This affects mostly the marking of the motor, occasionally also new technical requirements are introduced.

ABB refers to recently updated standards

In the implementation of ATEX 95 and ATEX 137 directives ABB refers to the IEC and EN standards which have been recently updated. Otherwise ABB refers to IEC standards.

Main standards for implementation Worker Protection Directive 1999/92/EC (ATEX 137)	
IEC/EN 60079-10	Classification of hazardous areas (gas areas)
IEC/EN 61241-10	Classification of areas where combustible dusts are or may be present
IEC/EN 60079-14	Installation rules of gas equipment
IEC/EN 61241-14	Selection and Installation of Ex tD (DIP) equipment.
IEC/EN 60079-17	Electrical installations Inspection and maintenance
IEC/EN 60079-19	Equipment Repair and overhaul

Motors for EU motor efficiency levels

A new Europe-wide agreement will ensure that the efficiency levels of electric motors manufactured in Europe are clearly displayed. In contrast to the American legislation on motor efficiency the European agreement does not establish mandatory efficiency levels. It basically establishes three classes giving motor manufacturers an incentive to qualify for a higher class.

ABB is one of only a handful of leading motor manufacturers in Europe, to have a motor range to meet or exceed the minimum efficiencies stated in the highest level of the EU agreement of LV motors.

EU efficiency classes for 2 pole motors.

Output KW	2-pole Boarderline	
	EFF2/EFF3	EFF1/1FF2
1.1	76.2	82.8
1.5	78.5	84.1
2.2	81.0	85.6
3	82.6	86.7
4	84.2	87.6
5.5	85.7	88.6
7.5	87.0	89.5
11	88.4	90.5
15	89.4	91.3
18.5	90.0	91.8
22	90.5	92.2
30	91.4	92.9
37	92.0	93.3
45	92.5	93.7
55	93.0	94.0
75	93.6	94.6
90	93.9	95.0

IECEx Scheme

The IECEx Scheme is an International Certification Scheme covering both apparatus and services for explosive atmospheres, as the internationally accepted means of demonstrating compliance with IEC standards. It comprises the following two international programs:

- IECEx Certified Equipment Program, covering Ex products
- IECEx Certified Service Facilities Program covering Ex Repair and Overhaul Workshops

It is a voluntary scheme which provides confidence that products and services covered by an IECEx certificate meet the specified requirements related to the hazardous area concerned (included Zone 2 / 22) as the internationally accepted means of demonstrating claimed compliance with an IEC Standard.

The management of this Scheme includes Certification Bodies of 26 countries around the world (experts, manufacturers, end users, regulators).

For more information please visit www.iecex.com.

ABB is relying on the IECEx Scheme and a large range of Ex motors are tested and certified according to this.

Main standards complying with the “EHSR’s” of Products Directive 94/9/EC (ATEX 95)	
EN 60079-0	General requirements for gas
EN 61241-0	General requirements for dust
EN 60079-1	Flame proof enclosure ‘d’
EN 60079-2	Pressurized enclosure ‘p’
EN 60079-7	Equipment protection by increased safety ‘e’
EN 60079-15	Construction test and marking of type of protection ‘n’
EN 61241-1	Protection by enclosure ‘tD’

These efficiency levels apply to 2-and-4-pole three phase squirrel cage induction motors rated for 400V, 50Hz with S1 duty class with the output 1.1 to 90kW, which account for the largest volume on the market.

The efficiency of motor from different manufacturers are collated in a database. EURODEEM. published by the European Commission. It is accessible over the internet at <http://jamest.jrc.it/projects/eem/eurodeem.htm>.

EU efficiency classes for 4 pole motors.

Output KW	4-pole Boarderline	
	EFF2/EFF3	EFF1/1FF2
1.1	76.2	83.8
1.5	78.5	85.0
2.2	81.0	86.4
3	82.6	87.4
4	84.2	88.3
5.5	85.7	89.2
7.5	87.0	90.1
11	88.4	91.0
15	89.4	91.8
18.5	90.0	92.2
22	90.5	92.6
30	91.4	93.2
37	92.0	93.6
45	92.5	93.9
55	93.0	94.2
75	93.6	94.7
90	93.9	95.0

Hazardous areas

Hazardous areas worldwide are classified by zone, according to the risk posed by explosive gas or dust in the atmosphere.

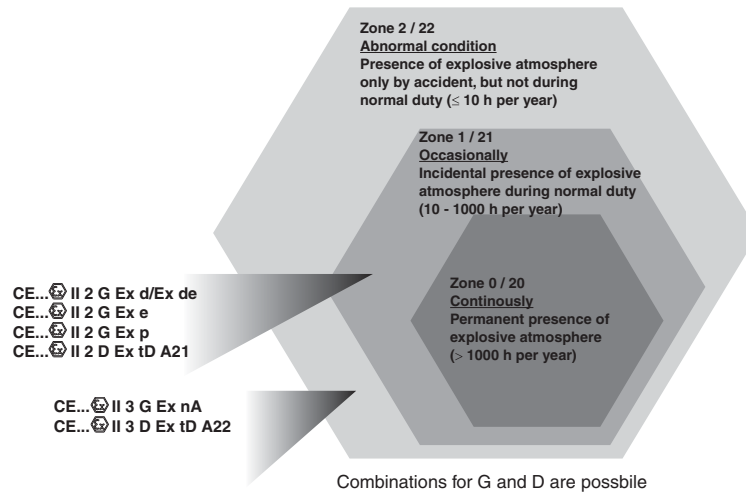

Classification of hazardous locations according to CENELEC and IEC

The definition of areas according to the presence of atmosphere are set up in the following standards:

EN 60079-10	Gas
EN 61241-1	Dust
IEC 60079-10	Gas
IEC 61241-1	Dust

Explosive atmosphere	Permanent presence	Incidental presence (normal operation conditions)	Accidental presence (abnormal operation conditions)
Gas ('G')	Zone 0	Zone 1	Zone 2
Dust ('D' / 'DIP' / 'Ex tD')	Zone 20	Zone 21	Zone 22

Note: In certain countries Ex d and Ex e motors are also used in Zone 2.

Marking temperatures, gas groups and hazardous areas

To ensure equipment can be safely used in potentially explosive atmospheres, the hazardous areas where the equipment is installed must be known. Temperature class of equipment must be compared with the spontaneous ignition temperature of the gas mixtures concerned and its gas group must be known in specific cases (e.g. flame proof protection).

Categories or classification

The ATEX Directive has introduced the concept of "Categories" which is a way of expressing the capability of equipment respecting the EHSR versus the Zone where the equipment is installed.

Category 1	according to Annex 1 of ATEX 95 used in Zone 0 or Zone 20
Category 2	according to Annex 1 of ATEX 95 used in Zone 1 or 21
Category 3	according to Annex 1 of ATEX 95 used in Zone 2 or 22

Classification

	Category equipment	Inflammable substances	Level of protection	Fault protection	Comparison with present practice and IEC
Equipment group I (mines)	M1	Methane, dust	Very high level	2 types of protection or 2 independent faults	Group I
	M2	Methane, dust	High level	1 type of protection Normal operation	Group I
Equipment group II (surface)	1	Gas, vapours, mist, dust	Very high level	2 types of protection or 2 independent faults	Group II Zone 0 (gas) / Zone 20 (dust)
	2	Gas, vapours, mist, dust	High level	1 type of protection Habitual frequent malfunction	Group II Zone 1 (gas) / Zone 21 (dust)
	3	Gas, vapours, mist, dust	Normal	Required level of protection	Group II Zone 2 (gas) / Zone 22 (dust)

Temperature classes

Temperature class	Ignition temperature for the gas/vapour °C	Max. permitted temperature equipment °C
T1	> 450	450
T2	> 300 < 450	300
T3	> 200 < 300	200
T4	> 135 < 200	135
T5	> 100 < 135	100
T6	> 85 < 100	85

Grouping of electrical apparatus

Group I	Apparatus for coal mines susceptible to firedamp
Group II	Apparatus for explosive atmospheres other than mines; surface industries
IIA, IIB, IIC	Group II is subdivided for Ex d and Ex i -equipment according to the severity of the environment. IIC is the highest rating; a motor from one of the higher categories can also be used in a lower category environment

Marking of equipment

Protection type marking:

EEx according to the EN standards series 50000

Ex according to the EN standards series 60079 and 61241

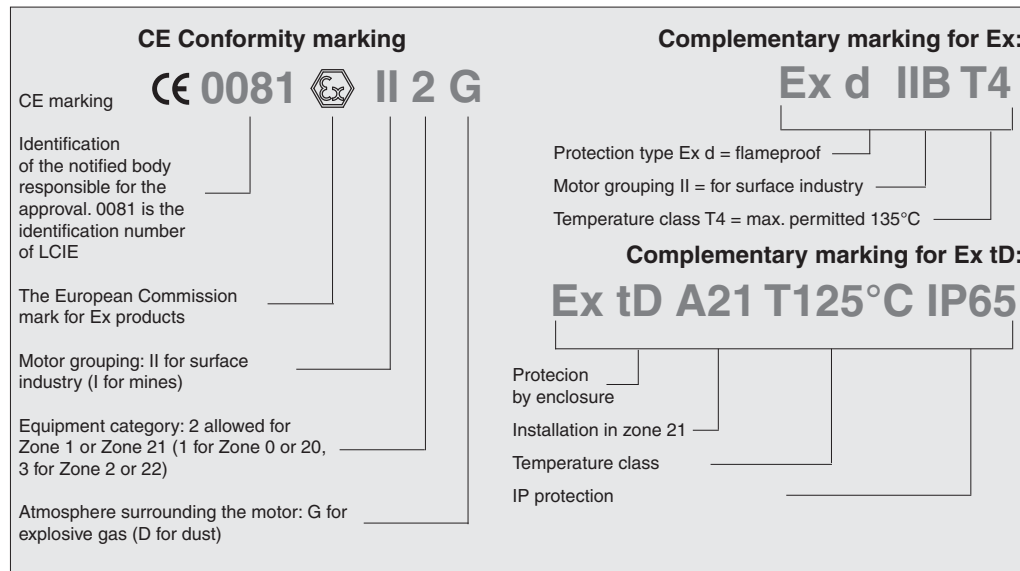

Selection of products for hazardous areas

EN Standard for Group II: Gas environments EN Standard for Group II: Dust environments

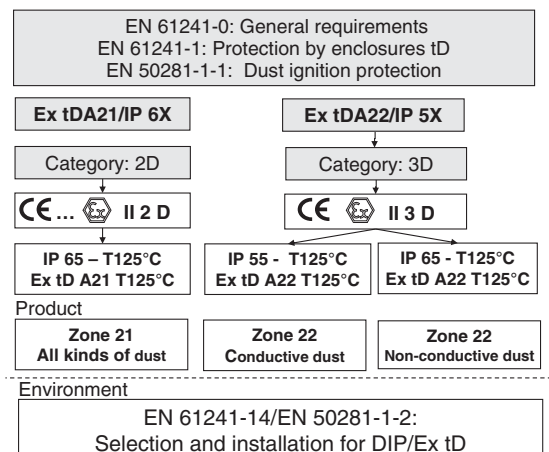
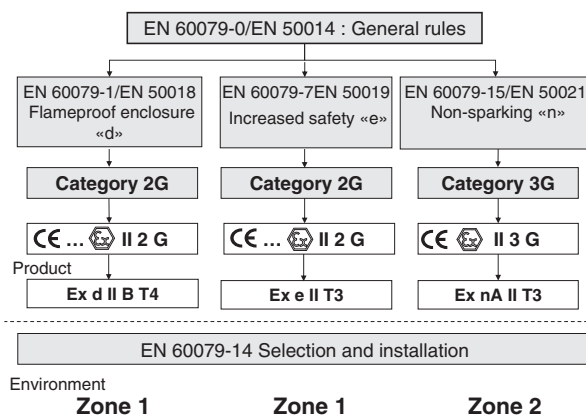

General about hazardous areas

Preamble

In hazardous areas, it is the utmost importance to ensure the safe use of electrical apparatus. To this end, many countries have regulations concerning both the design and use of such apparatus. These regulations are becoming increasingly harmonized within the framework of IEC recommendations and European Standards.

The hazard may be due to an explosive atmosphere composed of a mixture of gas, vapors or dusts with air. This chapter only deals with safety in explosive gas atmospheres for which European Standards exist. ABB has a full range of flameproof motors certified according to IECEx.

Flameproof enclosure Ex d and Ex de

The motor enclosure shall be designed in such a way that no internal explosion can be transmitted to the explosive atmosphere surrounding the motor. The enclosure must withstand, without damage, any pressure levels caused by an internal explosion. The shape, length and gap of part assembly joints, at shaft opening, cable entries, etc., shall be designed to allow for throttling and cooling of hot gases escaping outside. The standards emphasize the impact of an explosive atmosphere (for instance, explosion pressure) over constructional requirements of such apparatus.

The temperature of the motor's external enclosure should not exceed the self-ignition temperature of the explosive atmosphere of the installation area during normal operation. For this reason, rated output depends on this rated maximum temperature for the considered area.

No motor device outside the flameproof enclosure (e.g., ventilation) shall be a potential source of sparks, arcs or dangerous overheating.

Variants combining two types of protection usually combine "d" and "e" protection. The most commonly used and recognized by the CENELEC European Standards is the Ex de variant. The motor is designed with an Ex d flameproof enclosure, while the terminal box features an Ex e increased safety protection. Such design combines the superior safety degree of the "d" type of protection with the less stringent electrical connection requirements of increased safety motors.

Motors featuring dual protection are seldom encountered - such as an increased safety motor with a flame-proof enclosure designated Ex e / Ex d in European Standards.



EC Declaration of Conformity

The Manufacturer: ABB Shanghai Motors Co., Ltd
 N° 88 Tiansong Road, Minhang (Economic & Technical Development Zone)
 200245 - Shanghai, China

hereby declares that

The Products: 3-phase induction motors, series M2JA, M2GP - IEC shaft height 80 - 355, as listed on page 2 in this document, are in conformity with provisions of the following Council Directive:

Directive 94/9/EC (ATEX of 23 March 1994).

In respect of product categories the motors are in conformity with provisions of the following harmonized standards:

For M2JA :
 EN 60079-0 (2006), EN 60079-1 (2004)

A Notification LCIE 03 ATEX Q 8094 according to annex IV of Directive has been obtained and an EC-type examination certificate LCIE ... ATEX ... has been delivered for each type designation listed on page 2 of this document

For M2GP :
 EN 60079-0 (2006), EN 60079-15 (2005)

A Type examination certificate LCIE ... ATEX ... listed on page 2 of this document has been obtained.

Changes of the newest revisions of above standards do not effect the construction of the listed motors, which thus comply with the Essential Health and Safety Requirements in Annex II of said directive.

Note:
 The motor range listed have been certified according to old EN Standards range (EN 50014 / EN50018 & EN 50021).
 According to decision of "ATEX European Standing Committee" and after consulting Notified Bodies, ABB is going to continue with the process already started to move the motor certifications from EN 500XX series of standards to EN 60079-0 / EN 60079-1 / EN 60079-15

The Notified Body responsible for monitoring the ATEX Directive is LCIE Fontenay Aux Roses France. Identification number 0081.

Signed by 

Title: Javis-Li Xu
 Chief Engineer, Manager, Technical & Quality Control Dept.

Date: January 19th, 2009







ABB Shanghai Motors

N° 88 Tiansong Road, Minhang (Economic & Technical Development Zone) 200245 Shanghai, China
 Telephone: +86 21 5472 3133
 Internet: www.abb.com.cn
 e-mail: first_name.last_name@sh.abb.com
 Telefax: +86 21 5472 5025



<p>(A1) ANNEXE</p> <p>(A2) ATTESTATION D'EXAMEN CE DE TYPE</p> <p style="text-align: center;">LCIE 04 ATEX 6106</p> <p>(A3) Description de l'équipement ou du système de protection : Moteur triphasé à courant alternatif Type : M2JA315...</p> <p>Moteur asynchrone avec carcasse antidéflagrante et boîte à bornes antidéflagrante.</p> <p>Ce certificat concerne les types suivants: M2JA315S2A, M2JA315M2A, M2JA315L2B, M2JA315S4A, M2JA315M4A, M2JA315L4A, M2JA315L4B, M2JA315S6A, M2JA315M6A, M2JA315L6A, M2JA315L6B, M2JA315S8A, M2JA315M8A, M2JA315L8A, M2JA315L8B.</p> <p>M2JA : Gamme des moteurs EEx d 315 : Hauteur d'axe M : Dimension montage carcasse 2 : Nombre de pôles A : Longueur de la carcasse</p> <p>Le démarrage direct en dessous de la gamme de température -40°C à -20°C est interdit. Des mesures appropriées doivent être prises pour préchauffer le moteur et garder la température de l'enveloppe du moteur au-dessus de -20°C par des réchauffeurs et le chauffage du bobinage par une alimentation basse tension pendant un certain temps. Ce courant se produisant dans les enroulements n'excèdera pas le courant défini sur la plaque signalétique.</p> <p>Les paramètres électriques sont les suivants :</p> <p>Tension nominale : 380-690V, 50Hz 440-480V, 60Hz</p> <p>Service : S1</p> <p>Variations électriques et mécaniques définies dans les documents descriptifs du constructeur (voir A4).</p> <p>Le marquage est le suivant :</p> <p>ABB Motors Adresse Type M2JA315... n° de fabrication Année de fabrication IEC Ex d EEx d IIC T1 to T5 LCIE 04 ATEX 6106 Caractéristiques électriques (Us - V, Is - A, Pa - kW, F - Hz, tr/min ... Cos φ - ...) NE PAS OUVRIR SOUS TENSION (sur le couvercle)</p> <p>Le marquage CE est accompagné du numéro d'identification de l'organisme notifié responsable de la surveillance du système de qualité (0081 pour le LCIE).</p> <p>Le matériel devra également comporter le marquage normalement prévu par les normes de construction du matériel électrique concerné.</p>	<p>(A1) SCHEDULE</p> <p>(A2) EC TYPE EXAMINATION CERTIFICATE</p> <p style="text-align: center;">LCIE 04 ATEX 6106</p> <p>(A3) Description of Equipment or Protective System: Three-phase AC motor Type : M2JA315...</p> <p>Asynchronous motor with flameproof frame and flameproof terminal box.</p> <p>This certificate covers the following types: M2JA315S2A, M2JA315M2A, M2JA315L2B, M2JA315S4A, M2JA315M4A, M2JA315L4A, M2JA315L4B, M2JA315S6A, M2JA315M6A, M2JA315L6A, M2JA315L6B, M2JA315S8A, M2JA315M8A, M2JA315L8A, M2JA315L8B.</p> <p>M2JA : EEx d motor series 315 : Frame size M : Frame mounting dimension 2 : Pole number A : Frame length</p> <p>Direct starting under range -40°C to -20°C is prohibited.</p> <p>Appropriate measures should be taken to preheat motors to keep the temperature on the motor enclosure above -20°C by space heaters and heating stator windings with low voltage supply for a certain time. This direct current generating in the windings shall not exceed the rated current on the nameplate.</p> <p>The electrical parameters are the following :</p> <p>Rated voltage : 380-690V, 50Hz 440-480V, 60Hz</p> <p>Duty : S1</p> <p>Electrical and mechanical variations are defined within the descriptive documents established by the manufacturer (see A4).</p> <p>The marking is the following :</p> <p>ABB Motors Address Type M2JA315... Serial number Year of construction : IEC Ex d EEx d IIC T1 to T5 LCIE 04 ATEX 6106 Electrical characteristics (Us - V, Is - A, Pa - kW, F - Hz, r/min ... Cos φ - ...) DO NOT OPEN WHILE ENERGIZED (on cover)</p> <p>The CE marking shall be accompanied by the identification number of the notified body responsible for surveillance of the approved quality system (0081 for LCIE).</p> <p>The equipment must also carry the usual marking required by the manufacturing standards applying to such equipments.</p>
---	--

Page 2/3

 <p>1 ATTESTATION D'EXAMEN CE DE TYPE</p> <p>2 Appareils et systèmes de protection destinés à être utilisés en atmosphères explosibles Directive 94/9/CE</p> <p>3 Numéro de l'attestation CE de type LCIE 04 ATEX 6106</p> <p>4 Appareil ou système de protection : Moteur triphasé à courant alternatif Type : M2JA315...</p> <p>5 Demandeur : ABB Shanghai Motors Co. Ltd</p>	 <p>1 EC TYPE E</p> <p>2 Equipment or protective system intended for use in potentially explosive atmospheres Directive 94/9/EC</p> <p>3 EC type Examination Certificate number LCIE 04 ATEX 6106</p> <p>4 Equipment or protective system : Three-phase AC motor Type : M2JA315...</p> <p>5 Applicant : ABB Shanghai Motors Co. Ltd</p>	 <p>1 ATTESTATION D'EXAMEN CE DE TYPE</p> <p>2 Appareils et systèmes de protection destinés à être utilisés en atmosphères explosibles Directive 94/9/CE</p> <p>3 Numéro de l'attestation CE de type LCIE 04 ATEX 6106</p> <p>4 Appareil ou système de protection : Moteur triphasé à courant alternatif Type : M2JA315...</p> <p>5 Demandeur : ABB Shanghai Motors Co. Ltd</p>	 <p>1 EC TYPE EXAMINATION CERTIFICATE</p> <p>2 Equipment or protective system intended for use in potentially explosive atmospheres Directive 94/9/EC</p> <p>3 EC type Examination Certificate number LCIE 04 ATEX 6106</p> <p>4 Equipment or protective system : Three-phase AC motor Type : M2JA315...</p> <p>5 Applicant : ABB Shanghai Motors Co. Ltd</p>
 <p>1 ATTESTATION D'EXAMEN CE DE TYPE</p> <p>2 Appareils et systèmes de protection destinés à être utilisés en atmosphères explosibles Directive 94/9/CE</p> <p>3 Numéro de l'attestation CE de type LCIE 04 ATEX 6106</p> <p>4 Appareil ou système de protection : Moteur triphasé à courant alternatif Type : M2JA315...</p> <p>5 Demandeur : ABB Shanghai Motors Co. Ltd</p> <p>6 Adresse : 8 Guang Xing Rd., Rong Bei Twn Songjiang District, Shanghai - CHINA</p> <p>7 Cet appareil ou système de protection et ses variantes éventuelles acceptées est décrit dans l'annexe de la présente attestation et dans les documents décrits cités en annexe.</p> <p>8 La LCIE, organisme notifié sous la référence 0081 conformément à l'article 9 de la directive 94/9/CE du Parlement européen et du Conseil du 23 mars 1994, certifie que cet appareil ou système de protection est conforme aux exigences essentielles en ce qui concerne la sécurité et la santé.</p>	 <p>1 EC TYPE E</p> <p>2 Equipment or protective system intended for use in potentially explosive atmospheres Directive 94/9/EC</p> <p>3 EC type Examination Certificate number LCIE 04 ATEX 6106</p> <p>4 Equipment or protective system : Three-phase AC motor Type : M2JA315...</p> <p>5 Applicant : ABB Shanghai Motors Co. Ltd</p> <p>6 Address : 8 Guang Xing Rd., Rong Bei Twn Songjiang District, Shanghai - CHINA</p> <p>7 This equipment or protective system and any acceptable variation thereto is specified in the schedule to this certificate and the documents therein referred to.</p> <p>8 LCIE, notified body number 0081 in accordance with article 9 of the Directive 94/9/EC of the European Parliament and Council of 23 March 1994, certifies that this equipment or protective system has been found to comply with the essential Health and Safety Requirements relating to the design and construction of equipment and protective system intended for use in potentially explosive atmospheres, given in Annex II of the Directive.</p>	 <p>1 ATTESTATION D'EXAMEN CE DE TYPE</p> <p>2 Appareils et systèmes de protection destinés à être utilisés en atmosphères explosibles Directive 94/9/CE</p> <p>3 Numéro de l'attestation CE de type LCIE 04 ATEX 6106</p> <p>4 Appareil ou système de protection : Moteur triphasé à courant alternatif Type : M2JA315...</p> <p>5 Demandeur : ABB Shanghai Motors Co. Ltd</p>	 <p>1 EC TYPE EXAMINATION CERTIFICATE</p> <p>2 Equipment or protective system intended for use in potentially explosive atmospheres Directive 94/9/EC</p> <p>3 EC type Examination Certificate number LCIE 04 ATEX 6106</p> <p>4 Equipment or protective system : Three-phase AC motor Type : M2JA315...</p> <p>5 Applicant : ABB Shanghai Motors Co. Ltd</p>
 <p>1 ATTESTATION D'EXAMEN CE DE TYPE</p> <p>2 Appareils et systèmes de protection destinés à être utilisés en atmosphères explosibles Directive 94/9/CE</p> <p>3 Numéro de l'attestation CE de type LCIE 04 ATEX 6106</p> <p>4 Appareil ou système de protection : Moteur triphasé à courant alternatif Type : M2JA315...</p> <p>5 Demandeur : ABB Shanghai Motors Co. Ltd</p> <p>6 Adresse : 8 Guang Xing Rd., Rong Bei Twn Songjiang District, Shanghai - CHINA</p> <p>7 Cet appareil ou système de protection et ses variantes éventuelles acceptées est décrit dans l'annexe de la présente attestation et dans les documents décrits cités en annexe.</p> <p>8 La LCIE, organisme notifié sous la référence 0081 conformément à l'article 9 de la directive 94/9/CE du Parlement européen et du Conseil du 23 mars 1994, certifie que cet appareil ou système de protection est conforme aux exigences essentielles en ce qui concerne la sécurité et la santé pour la conception et la construction d'appareils et de systèmes de protection destinés à être utilisés en atmosphères explosibles, données dans l'annexe II de la directive. Les vérifications et épreuves figurent dans notre rapport confidentiel N° 60024635-518806-12.</p> <p>9 Le respect des exigences essentielles en ce qui concerne la sécurité et la santé est assuré par la conformité aux documents suivants : - EN 50014 (1997) + amendements 1 et 2 - EN 50018 (2000)</p> <p>10 Le signe X lorsqu'il est placé à la suite du numéro de l'attestation, indique que ce matériel ou système de protection est soumis aux conditions spéciales pour une utilisation sûre, mentionnées dans l'annexe de la présente attestation.</p> <p>11 Cette attestation d'examen CE de type concerne uniquement la conception et la construction de l'appareil ou du système de protection spécifié, conformément à la directive 94/9/CE. Des exigences supplémentaires de cette directive sont applicables pour la fabrication et la fourniture de l'appareil ou du système de protection.</p> <p>12 Le marquage de l'appareil ou du système de protection devra comporter, entre autres indications utiles, les mentions suivantes : ⊕ II 2 G EEx d IIC T1 à T5</p> <p>Fontenay-aux-Roses, le 20 septembre 2004</p>	 <p>1 EC TYPE EXAMINATION CERTIFICATE</p> <p>2 Equipment or protective system intended for use in potentially explosive atmospheres Directive 94/9/EC</p> <p>3 EC type Examination Certificate number LCIE 04 ATEX 6106</p> <p>4 Equipment or protective system : Three-phase AC motor Type : M2JA315...</p> <p>5 Applicant : ABB Shanghai Motors Co. Ltd</p> <p>6 Address : 8 Guang Xing Rd., Rong Bei Twn Songjiang District, Shanghai - CHINA</p> <p>7 This equipment or protective system and any acceptable variation thereto is specified in the schedule to this certificate and the documents therein referred to.</p> <p>8 LCIE, notified body number 0081 in accordance with article 9 of the Directive 94/9/EC of the European Parliament and Council of 23 March 1994, certifies that this equipment or protective system has been found to comply with the essential Health and Safety Requirements relating to the design and construction of equipment and protective system intended for use in potentially explosive atmospheres, given in Annex II of the Directive. The examination and test results are recorded in confidential report No 60024635-518806-12.</p> <p>9 Compliance with the Essential Health and Safety Requirements has been assured by compliance with : - EN 50014 (1997) + amendments 1 and 2 - EN 50018 (2000)</p> <p>10 If the sign X is placed after the certificate number, it indicates that the equipment or protective system is subject to special conditions for safe use specified in the schedule to this certificate.</p> <p>11 This EC Type examination certificate relates only to the design and construction of this specified equipment or protective system in accordance with the Directive 94/9/EC. Further requirements of the Directive apply to the manufacture and supply of this equipment or protective system.</p> <p>12 The marking of the equipment or protective system shall include the following : ⊕ II 2 G EEx d IIC T1 to T5</p> <p>Le Directeur de l'organisme certificateur Manager of the certification body</p> <p>Timbre sec / Dry seal</p>	 <p>1 ATTESTATION D'EXAMEN CE DE TYPE</p> <p>2 Appareils et systèmes de protection destinés à être utilisés en atmosphères explosibles Directive 94/9/CE</p> <p>3 Numéro de l'attestation CE de type LCIE 04 ATEX 6106</p> <p>4 Appareil ou système de protection : Moteur triphasé à courant alternatif Type : M2JA315...</p> <p>5 Demandeur : ABB Shanghai Motors Co. Ltd</p>	 <p>1 EC TYPE EXAMINATION CERTIFICATE</p> <p>2 Equipment or protective system intended for use in potentially explosive atmospheres Directive 94/9/EC</p> <p>3 EC type Examination Certificate number LCIE 04 ATEX 6106</p> <p>4 Equipment or protective system : Three-phase AC motor Type : M2JA315...</p> <p>5 Applicant : ABB Shanghai Motors Co. Ltd</p>
 <p>1 ATTESTATION D'EXAMEN CE DE TYPE</p> <p>2 Appareils et systèmes de protection destinés à être utilisés en atmosphères explosibles Directive 94/9/CE</p> <p>3 Numéro de l'attestation CE de type LCIE 04 ATEX 6106</p> <p>4 Appareil ou système de protection : Moteur triphasé à courant alternatif Type : M2JA315...</p> <p>5 Demandeur : ABB Shanghai Motors Co. Ltd</p>	 <p>1 EC TYPE EXAMINATION CERTIFICATE</p> <p>2 Equipment or protective system intended for use in potentially explosive atmospheres Directive 94/9/EC</p> <p>3 EC type Examination Certificate number LCIE 04 ATEX 6106</p> <p>4 Equipment or protective system : Three-phase AC motor Type : M2JA315...</p> <p>5 Applicant : ABB Shanghai Motors Co. Ltd</p>		
 <p>1 ATTESTATION D'EXAMEN CE DE TYPE</p> <p>2 Appareils et systèmes de protection destinés à être utilisés en atmosphères explosibles Directive 94/9/CE</p> <p>3 Numéro de l'attestation CE de type LCIE 04 ATEX 6106</p> <p>4 Appareil ou système de protection : Moteur triphasé à courant alternatif Type : M2JA315...</p> <p>5 Demandeur : ABB Shanghai Motors Co. Ltd</p> <p>6 Adresse : 8 Guang Xing Rd., Rong Bei Twn Songjiang District, Shanghai - CHINA</p> <p>7 Cet appareil ou système de protection et ses variantes éventuelles acceptées est décrit dans l'annexe de la présente attestation et dans les documents décrits cités en annexe.</p> <p>8 La LCIE, organisme notifié sous la référence 0081 conformément à l'article 9 de la directive 94/9/CE du Parlement européen et du Conseil du 23 mars 1994, certifie que cet appareil ou système de protection est conforme aux exigences essentielles en ce qui concerne la sécurité et la santé pour la conception et la construction d'appareils et de systèmes de protection destinés à être utilisés en atmosphères explosibles, données dans l'annexe II de la directive. Les vérifications et épreuves figurent dans notre rapport confidentiel N° 60024635-518806-12.</p> <p>9 Le respect des exigences essentielles en ce qui concerne la sécurité et la santé est assuré par la conformité aux documents suivants : - EN 50014 (1997) + amendements 1 et 2 - EN 50018 (2000)</p> <p>10 Le signe X lorsqu'il est placé à la suite du numéro de l'attestation, indique que ce matériel ou système de protection est soumis aux conditions spéciales pour une utilisation sûre, mentionnées dans l'annexe de la présente attestation.</p> <p>11 Cette attestation d'examen CE de type concerne uniquement la conception et la construction de l'appareil ou du système de protection spécifié, conformément à la directive 94/9/CE. Des exigences supplémentaires de cette directive sont applicables pour la fabrication et la fourniture de l'appareil ou du système de protection.</p> <p>12 Le marquage de l'appareil ou du système de protection devra comporter, entre autres indications utiles, les mentions suivantes : ⊕ II 2 G EEx d IIC T1 to T5</p> <p>Fontenay-aux-Roses, le 20 septembre 2004</p>	 <p>1 EC TYPE EXAMINATION CERTIFICATE</p> <p>2 Equipment or protective system intended for use in potentially explosive atmospheres Directive 94/9/EC</p> <p>3 EC type Examination Certificate number LCIE 04 ATEX 6106</p> <p>4 Equipment or protective system : Three-phase AC motor Type : M2JA315...</p> <p>5 Applicant : ABB Shanghai Motors Co. Ltd</p> <p>6 Address : 8 Guang Xing Rd., Rong Bei Twn Songjiang District, Shanghai - CHINA</p> <p>7 This equipment or protective system and any acceptable variation thereto is specified in the schedule to this certificate and the documents therein referred to.</p> <p>8 LCIE, notified body number 0081 in accordance with article 9 of the Directive 94/9/EC of the European Parliament and Council of 23 March 1994, certifies that this equipment or protective system has been found to comply with the essential Health and Safety Requirements relating to the design and construction of equipment and protective system intended for use in potentially explosive atmospheres, given in Annex II of the Directive. The examination and test results are recorded in confidential report No 60024635-518806-12.</p> <p>9 Compliance with the Essential Health and Safety Requirements has been assured by compliance with : - EN 50014 (1997) + amendments 1 and 2 - EN 50018 (2000)</p> <p>10 If the sign X is placed after the certificate number, it indicates that the equipment or protective system is subject to special conditions for safe use specified in the schedule to this certificate.</p> <p>11 This EC Type examination certificate relates only to the design and construction of this specified equipment or protective system in accordance with the Directive 94/9/EC. Further requirements of the Directive apply to the manufacture and supply of this equipment or protective system.</p> <p>12 The marking of the equipment or protective system shall include the following : ⊕ II 2 G EEx d IIC T1 to T5</p> <p>Le Directeur de l'organisme certificateur Manager of the certification body</p> <p>Timbre sec / Dry seal</p>		
 <p>1 ATTESTATION D'EXAMEN CE DE TYPE</p> <p>2 Appareils et systèmes de protection destinés à être utilisés en atmosphères explosibles Directive 94/9/CE</p> <p>3 Numéro de l'attestation CE de type LCIE 04 ATEX 6106</p> <p>4 Appareil ou système de protection : Moteur triphasé à courant alternatif Type : M2JA315...</p> <p>5 Demandeur : ABB Shanghai Motors Co. Ltd</p>	 <p>1 EC TYPE EXAMINATION CERTIFICATE</p> <p>2 Equipment or protective system intended for use in potentially explosive atmospheres Directive 94/9/EC</p> <p>3 EC type Examination Certificate number LCIE 04 ATEX 6106</p> <p>4 Equipment or protective system : Three-phase AC motor Type : M2JA315...</p> <p>5 Applicant : ABB Shanghai Motors Co. Ltd</p>		

Mechanical design

Totally enclosed, fan cooled IP55

Heavy duty design, manufactured from extra corrosion resistant cast iron materials to be used in all kind of environment. The motor is mechanically very strong and robust and as standard designed for additional energy saving through frequency converter drives.

Flexible cable entry direction

Terminal boxes are mounted on the top of the motors, right or left. Terminal boxes of motor size 71-132 can rotate 4x90°C, and those of 160-355 can rotate 2x180°C. All are easy to refit.

Powerful refit available

The motors satisfy the requirements of a wide range of environments and applications, such as improving protection, insulation level, regreasing facilities, dust-proof, sealing rings, rainproof are available, a full range of options are listed in page 13.

Insulation and insulation classes

According to IEC60085, insulating materials are divided into insulation classes. Each class has a designation corresponding to the temperature that is the upper limit of the range of application of the insulating material under normal operating condition.

The winding insulation of a motor is determined on the basis of the temperature rise in the motor and the ambient temperature. The insulation is normally dimensioned for the hottest point in the motor at its normal rated output and at ambient temperature of 40°C. Motors subjected to ambient temperatures above 40°C will generally have to be derated. In most cases, the standard rated outputs of motors from ABB Motors are based on the temperature rise for insulation classes B. Where the temperature rise is according to class F, this is specified in the data tables.

However, all the motors are designed with class F insulation, which permits a higher temperature rise than class B. The motors, therefore, have a generous over-load margin. If temperature rise to class F is allowed, the outputs given in the tables can generally be increased by about 12 %

Temperature limits are according to standards. The extra thermal margin when using class F insulation with class B temperature rise makes the motors more reliable.

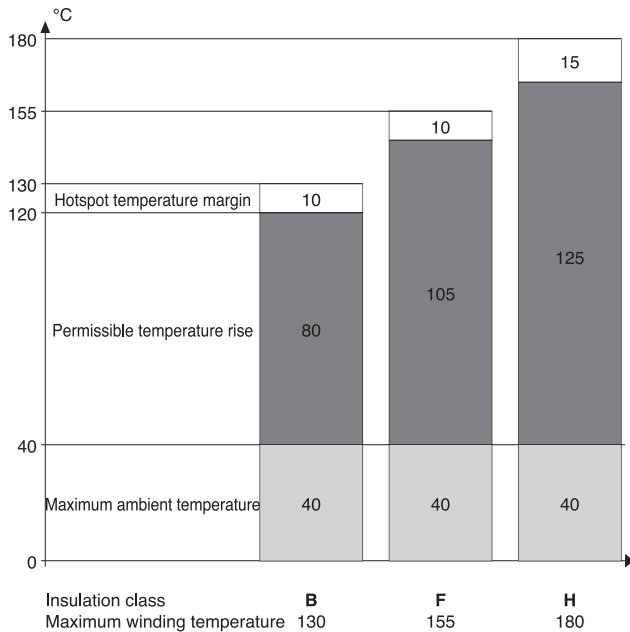

Safe margins per insulation class

Mounting arrangements

Foot-mounted motor

IM B3	IM V5	IM V6	IM B6	IM B7	IM B8
IM1001	IM1011	IM1031	IM1051	IM1061	IM1071

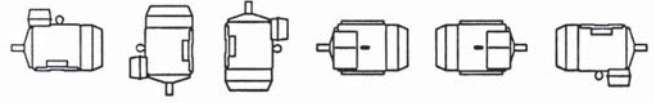

Flange-mounted motor, large flange

IM B5	IM V1	IM V3	*)	*)	*)
IM3001	IM3011	IM3031	IM3051	IM3061	IM3071

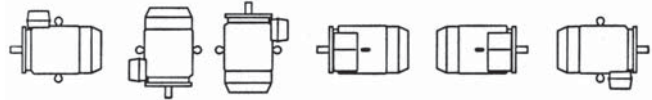

Flange-mounted motor, small flange

IM B14	IM V18	IM V19	*)	*)	*)
IM3601	IM3611	IM3631	IM3651	IM3661	IM3671

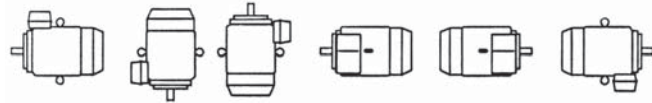

Foot-and flange-mounted motor with feet, large flange

IM B35	IM V15	IM V36	*)	*)	*)
IM2001	IM2011	IM2031	IM2051	IM2061	IM2071

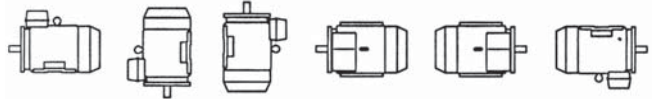

Foot-and flange-mounted motor with feet, small flange

IM B34					
IM2101	IM2111	IM2131	IM2131	IM2161	IM2171

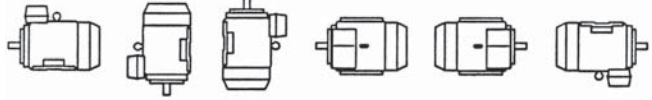

Foot-mounted motor, shaft with free extensions

IM1002	IM1012	IM1032	IM1052	IM1062	IM1072
--------	--------	--------	--------	--------	--------

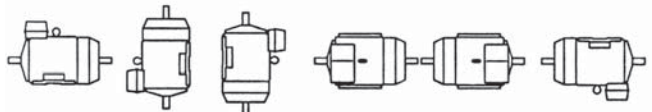

*) Not stated in IEC 60034-7

Product code pos.12

A = foot-mounted, term.box top	B = flange mounted, large flange
L = foot-mounted, term.box LHS	C = flange mounted, small flange
R = foot-mounted, term.box RHS	T = foot/flange -mounted, term.box LHS
H = foot/flange-mounted, term.box top	S = foot/flange-mounted, term.box RHS
J = foot/flange-mounted, small flange	

Motors for other voltages

Motors wound for a given voltage at 50Hz can also be used for other voltages. Recalculation factors for current and torque given are beside; efficiency, power factor and speed remain approximately the same. Guaranteed values available on request.

ABB Motors reserve the right to change the design, technical specification and dimensions without prior notice.

Motor wound for	230V	400V	500V	690V				
Connected to 50Hz	220V	230V	380V	415V	500V	550V	660V	690V
% of values at 400V, 50Hz								
Output	100	100	100	100	100	100	100	100
I_N	182	174	105	98	80	75	61	58
I_S/I_N	90	100	90	106	100	119	90	100
T_S/T_N	90	100	90	106	100	119	90	100
I_{MAX}/T_N	90	100	90	106	100	119	90	100

Motors wound for certain voltage at 50 Hz can be operated at 60 Hz, without modification, subject to the following changes in their data.

Motor wound for 50Hz	220V	380V			
Connected to 60Hz	220V	380V	415V	440V	460V
Data at 60Hz in percentage of values at 50Hz					
Output	100	100	110	115	120
r/min	120	120	120	120	120
I_N	98	98	98	100	100
I_S/I_N	83	83	95	100	105
T_N	83	83	91	96	100
T_S/T_N	70	70	85	95	100
I_{MAX}/T_N	85	85	93	98	103

Bearings and terminal boxes

The motors are normally fitted with single-row deep groove ball bearings as listed in the table below. Degree of protection of the standard terminal box is IP55. The motors are supplied with 2 cable entries as standard according to the table below.

Terminal boxes are mounted on top of the motor. The terminal box of motor sizes 71 to 132 can be turned 4 x 90° and in motors sizes 160 to 355 rotated 2 x 180°.

Type	Poles	Standard bearing type		Cable entry	
		D-end	N-end	Main	Auxiliary*
80M	2,4,6	6204 C3	6204 C3	1-M25X1.5	2-M20X1.5
90S	2,4,6	6205 C3	6205 C3	1-M25X1.5	2-M20X1.5
90L	2,4,6	6205 C3	6205 C3	1-M25X1.5	2-M20X1.5
100L	2,4,6,8	6206 C3	6206 C3	1-M32X1.5	2-M20X1.5
112M	2,4,6,8	6207 C3	6207 C3	1-M32X1.5	2-M20X1.5
132S	2,4,6,8	6208 C3	6208 C3	1-M32X1.5	2-M20X1.5
132M	2,4,6,8	6208 C3	6208 C3	1-M32X1.5	2-M20X1.5
160M	2,4,6,8	6309 C3	6309 C3	2-M40X1.5	1-M20X1.5
160L	2,4,6,8	6309 C3	6309 C3	2-M40X1.5	1-M20X1.5
180M	2,4,6,8	6310 C3	6309 C3	2-M40X1.5	1-M20X1.5
180L	2,4,6,8	6310 C3	6309 C3	2-M40X1.5	1-M20X1.5
200L	2,4,6,8	6312 C3	6310 C3	2-M50X1.5	2-M20X1.5
225S	2,4,6,8	6313 C3	6312 C3	2-M50X1.5	2-M20X1.5
225M	2,4,6,8	6313 C3	6312 C3	2-M50X1.5	2-M20X1.5
250M	2,4,6,8	6315 C3	6313 C3	2-M63X1.5	2-M20X1.5
280S	2	6316 C3	6316 C3	2-M63X1.5	2-M20X1.5
280S	4,6,8	6316 C3	6316 C3	2-M63X1.5	2-M20X1.5
280M	2	6316 C3	6316 C3	2-M63X1.5	2-M20X1.5
280M	4,6,8	6316 C3	6316 C3	2-M63X1.5	2-M20X1.5
315S	2	6316 C3	6316 C3	2-M63X1.5	2-M20X1.5
315S	4,6,8	6319 C3	6316 C3	2-M63X1.5	2-M20X1.5
315M	2	6316 C3	6316 C3	2-M63X1.5	2-M20X1.5
315M	4,6,8	6319 C3	6316 C3	2-M63X1.5	2-M20X1.5
315L	2	6316 C3	6316 C3	2-M63X1.5	2-M20X1.5
315L	4,6,8	6319 C3	6316 C3	2-M63X1.5	2-M20X1.5
355M	2	6319M C3	6319M C3	2-M80X1.5	2-M20X1.5
355M	4,6,8	6322 C3	6319 C3	2-M80X1.5	2-M20X1.5
355L	2	6319M C3	6319M C3	2-M80X1.5	2-M20X1.5
355L	4,6,8	6322 C3	6319 C3	2-M80X1.5	2-M20X1.5

Motors of terminal boxes:

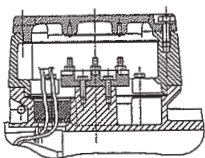

Terminal box for motors sizes 80 - 132

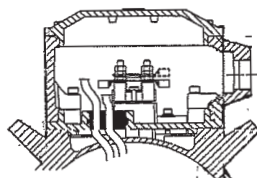

Terminal box for motors sizes 160 - 180

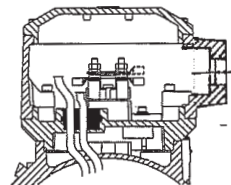

Terminal box for motors sizes 200 - 280

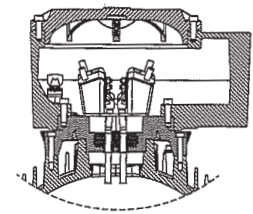

Terminal box for motors sizes 315 - 355

Permissible loadings on the shaft end

The tables below give the permissible radial force in Newton, assuming zero axial force. The values are based on normal conditions at 50 Hz and calculated bearing lives for motor sizes 71 to 355 of 20000 hours and 40000 hours.

Motors are foot-mounted IM B3 version with force directed sideways. In some cases the strength of the shaft affects the permissible forces.

At 60 Hz the values must be reduced by 10%. For two-speed motors, the values must be based on the higher speed.

Permissible loads of simultaneous radial and axial forces will be supplied on request.

Permissible radial forces

Motor size 71 to 355

20000 hours Ball bearings									
Motor size	2-pole		4-pole		6-pole		8-pole		
	X ₀ N	X _{max} N	X ₀ N	X _{max} N	X ₀ N	X _{max} N	X ₀ N	X _{max} N	
71M	381.1	322.2	479.6	405.4	555.1	469.2	-	-	
80M	624.2	509.4	788.3	643.3	906.7	739.9	996.7	813.4	
90S	686.0	542.2	869.5	687.2	1000.1	790.4	1095.4	865.8	
90L	696.4	564.2	884.7	716.8	1015.1	822.5	1112.0	901.0	
100L	979.4	784.8	1233.9	988.8	1419.1	1137.2	1565.7	1254.6	
112M	1257.8	1014.4	1592.1	1283.9	1831.1	1476.7	2020.1	1629.1	
132S	1435.0	1121.7	1820.5	1423.1	2079.1	1625.3	2299.1	1797.2	
132M	-	-	1840.2	1476.3	2106.5	1689.9	2329.4	1868.7	
160M	1544.0	1199.8	1947.5	1513.4	2231.9	1734.4	2465.0	1615.6	
160L	1562.7	1242.9	1971.2	1567.8	2259.0	1796.7	2495.0	1984.4	
180M	2983.6	2371.3	3759.1	2987.7	-	-	-	-	
180L	-	-	3801.5	3073.0	4351.6	3517.7	4800.4	3880.5	
200L	4089.8	3376.8	5161.5	4261.7	5908.5	4878.5	6517.9	5381.7	
225S	-	-	5762.8	4526.4	-	-	7260.7	5702.9	
225M	4591.0	3811.1	5790.9	4594.2	6643.9	5271.0	7296.0	5788.4	
250M	5111.6	4170.0	6439.9	5253.6	7388.1	6027.2	8113.0	6618.5	
280S	6000.2	4956.7	7570.1	6253.5	8679.2	7169.8	9537.5	7878.8	
280M	6048.5	5059.3	7631.5	6383.4	8750.0	7318.9	9615.4	8042.8	
315S	6602.4	5627.1	9533.5	7882.0	10916.1	9025.1	12028.5	9944.8	
315M	6677.1	5793.3	9647.8	8145.0	11047.2	9326.4	12173.2	10277.0	
315L	6675.9	5792.3	9648.0	8145.1	11045.3	9324.7	12171.2	10275.3	
355M	8280.0	6790.0	14060.0	11529.0	16089.0	13193.0	-	-	
355L	8372.0	6865.0	14136.0	11592.0	16175.0	13264.0	-	-	

40000 hours Ball bearings									
Motor size	2-pole		4-pole		6-pole		8-pole		
	X ₀ N	X _{max} N	X ₀ N	X _{max} N	X ₀ N	X _{max} N	X ₀ N	X _{max} N	
71M	302.5	255.7	380.7	321.8	440.5	372.4	-	-	
80M	495.4	404.3	625.7	510.6	719.6	587.3	791.1	645.6	
90S	544.5	430.4	690.1	545.4	793.8	627.3	869.5	687.2	
90L	552.7	447.8	702.2	568.9	805.7	652.8	882.6	715.1	
100L	777.3	622.9	979.4	784.8	1126.4	902.6	1242.7	995.8	
112M	998.3	805.1	1263.6	1019.1	1453.3	1172.0	1603.4	1293.1	
132S	1138.9	890.3	1444.9	1129.5	1650.2	1290.0	1824.8	1426.5	
132M	-	-	1460.6	1171.7	1672.0	1341.3	1848.8	1483.2	
160M	1225.5	952.3	1545.7	1201.2	1771.5	1376.6	1956.5	1520.4	
160L	1240.4	986.5	1564.5	1244.3	1793.0	1426.0	1980.3	1575.0	
180M	2368.1	1882.1	2983.6	2371.3	-	-	-	-	
180L	-	-	3017.2	2439.0	3453.9	2792.0	3810.1	3080.0	
200L	3246.1	2680.2	4096.7	3382.6	4689.6	3872.1	5173.3	4271.5	
225S	-	-	4574.0	3592.6	-	-	5762.8	4526.4	
225M	3643.9	3024.9	4596.2	3646.4	5273.3	4183.6	5790.9	4594.2	
250M	4057.0	3309.7	5111.1	5169.6	5863.7	4783.5	6438.9	5252.8	
280S	4761.8	3933.7	6007.7	4962.9	6888.0	5690.1	7569.1	6252.7	
280M	4799.8	4014.8	6056.1	5065.6	6943.7	5808.1	7630.5	6382.5	
315S	5239.0	4465.1	7565.3	6254.8	8662.6	7162.0	9545.4	7891.8	
315M	5297.9	4596.7	7655.6	6463.1	8766.3	7400.7	9659.8	8155.1	
315L	5296.6	4595.6	7655.4	6462.9	8764.6	7399.1	9657.9	8153.5	
355M	5612.0	4602.0	11100.0	9102.0	12741.0	10448.0	-	-	
355L	5612.0	4658.0	11100.0	9213.0	12741.0	10575.0	-	-	

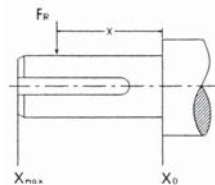

If the radial force is applied between points X₀ and X_{max}, the permissible force F_p can be calculated from the following formula: $F_p = F_{x0-X/E} (F_{x0} - F_{xmax})$ E=length of shaft extension in basic version

Permissible axial forces

The Following tables give the permissible axial forces in Newton, assuming zero radial force. The values are based on normal conditions at 50 Hz with standard bearings and calculated bearing life time of 20000 and 40000 hours.

At 60 Hz the values are to be reduced by 10%. For two-speed motors, the values are to be based on the higher speed. The permissible loads of simultaneous radial and axial forces will be supplied on request.

Given axial forces F_{AD}, assumes D-bearing locked by means of locking ring.

Mounting arrangement IM B3

20000 hours Ball bearings									
Motor size	2-pole		4-pole		6-pole		8-pole		
	FAD N	FAZ N	FAD N	FAZ N	FAD N	FAZ N	FAD N	FAZ N	
71M	268.3	268.3	362.9	362.9	438.6	438.6	-	-	
80M	434.8	434.8	592.9	592.9	712.6	712.6	804.0	804.0	
90S	471.8	471.8	647.0	647.0	778.2	778.2	873.0	873.0	
90L	471.8	471.8	648.9	648.9	778.2	778.2	873.0	873.0	
100L	648.3	648.3	883.7	883.7	1058.3	1058.3	1202.6	1202.6	
112M	843.0	843.0	1157.0	1157.0	1382.8	1382.8	1574.2	1574.2	
132S	947.2	947.2	1302.3	1302.3	1542.7	1542.7	1764.0	1764.0	
132M	-	-	1297.9	1297.9	1542.7	1542.7	1764.0	1764.0	
160M	1017.7	1017.7	1382.1	1382.1	1651.2	1651.2	1881.4	1881.4	
160L	1017.7	1017.7	1382.1	1382.1	1651.2	1651.2	1881.4	1881.4	
180M	1972.9	1972.9	2665.0	2665.0	-	-	-	-	
180L	-	-	2665.0	2665.0	3197.1	3197.1	3626.4	3626.4	
200L	2569.6	2569.6	3489.1	3489.1	4197.9	4197.9	4754.7	4754.7	
225S	-	-	3904.5	3904.5	-	-	5309.0	5309.0	
225M	2873.4	2873.4	3904.5	3904.5	4718.4	4718.4	5309.0	5309.0	
250M	3225.3	3225.3	4378.4	4378.4	5293.1	5293.1	5955.9	5955.9	
280S	3714.9	3714.9	5007.7	5007.7	6087.7	6087.7	6924.2	6924.2	
280M	3714.9	3714.9	5077.7	5077.7	6087.7	6087.7	6924.2	6924.2	
315S	3963.9	3963.9	6141.0	6141.0	7292.2	7292.2	8300.9	8300.9	
315M	3963.9	3963.9	6141.0	6141.0	7292.2	7292.2	8300.9	8300.9	
315L	3964.7	3964.7	6143.0	6143.0	7292.2	7292.2	8300.9	8300.9	
355-	5775.0	2310.0	8100.0	4050.0	9484.0	5160.0	10080.0	8420.0	

40000 hours Ball bearings									
Motor size	2-pole		4-pole		6-pole		8-pole		
	FAD N	FAZ N	FAD N	FAZ N	FAD N	FAZ N	FAD N	FAZ N	
71M	198.6	198.6	267.8	267.8	325.0	325.0	-	-	
80M	320.6	320.6	436.1	436.1	528.4	528.4	595.6	595.6	
90S	347.1	347.1	475.4	475.4	576.4	576.4	647.0	647.0	
90L	341.7	341.7	477.0	477.0	576.4	576.4	647.0	647.0	
100L	475.6	475.6	648.3	648.3	781.5	781.5	891.5	891.5	
112M	617.1	617.1	848.0	848.0	1019.4	1019.4	1167.3	1167.3	
132S	692.5	692.5	955.5	955.5	1135.8	1135.8	1306.7	1306.7	
132M	-	-	952.6	952.6	1135.8	1135.8	1306.7	1306.7	
160M	743.1	743.1	1019.2	1019.2	1214.3	1214.3	1391.0	1391.0	
160L	743.1	743.1	1019.2	1019.2	1214.3	1214.3	1391.0	1391.0	
180M	1441.7	1441.7	1972.9	1972.9	-	-	-	-	
180L	-	-	1972.9	1972.9	2346.4	2346.4	2673.2	2673.2	
200L	1888.2	1888.2	2575.9	2575.9	3077.9	3077.9	3499.8	3499.8	
225S	-	-	2878.0	2878.0	-	-	3904.5	3904.5	
225M	2117.4	2117.4	2878.0	2878.0	3457.5	3457.5	3904.5	3904.5	
250M	2379.2	2379.2	3225.3	3225.3	3879.3	3879.3	4378.4	4378.4	
280S	2766.7	2766.7	3721.9	3721.9	4509.5	4509.5	5077.7	5077.7	
280M	2766.7	2766.7	3721.9	3721.9	4509.5	4509.5	5077.7	5077.7	
315S	2965.5	2965.5	4478.5	4478.5	5357.8	5357.8	6153.3	6153.3	
315M	2965.5	2965.5	4478.5	4478.5	5357.8	5357.8	6153.3	6153.3	
315L	2965.8	2965.8	4479.5	4479.5	5357.8	5357.8	6153.3	6153.3	
355-	4675.0	1460.0	5770.0	2030.0	6411.0	2611.0	7106.0	3366.0	

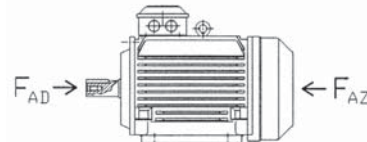

Rating plate

For motor sizes 80 to 132 the rating plate gives one current value for the voltage area. That is the highest current that can occur within the voltage area with the given output.

ABB ABB Motors Shanghai, China					
3~mot. M2JA132S4A					
1430/1700 r/min		5.5/6.33 kW		Ex d IIC T4 Gb	
cosφ 0.85/0.86		Cl. F		IP 55 AMB 40 °C	
V	380-420 Δ	11.3 50		A	Hz
	660-690 Y	6.52 50			
	440-480 Δ	11.23 60			
3GJA131101-ADC					
620B DDU/C3		620B DDU/C3		kg	
Q/JBQS 45		No.			
Cert.No. LCIE 04 ATEX6099					
CE 0081		Ex II2G		Date IEC60034-1	

For motor size 160 to 355 the rating plate is in table form giving values for speed, current and power factor for six voltages.

ABB ABB Motors Shanghai, China					
3~motor M2JA225M4A					
IEC 225M60		Ex d IIC T4 Gb			
S1		No.			
Date		Ins.cl. F		IP 55 AMB 40°C	
V	Hz	kW	r/min	A	cosφ
690 Y	50	45	1480	46.64	0.87
400 Δ	50	45	1480	80.45	0.87
660 Y	50	45	1475	48.31	0.88
380 Δ	50	45	1475	83.90	0.88
415 Δ	50	45	1480	79.37	0.85
440 Δ	60	51.8	1770	83.23	0.88
Prod.code 3GJA22301-ADC					
Cert.no LCIE 04 ATEX 6103					
6313/C3		6312/C3		kg	
CE 0081		Ex II2G		IEC 60034-1 Q/JBQS 45	

Ordering information

Sample order

When placing an order, the motor type, size and product code must be specified. The product code of the motor is composed in various way, in accordance with the following examples.

A	B	C				D,	E,	F		G	
M2JA	132S4A	3GJA	13	2	101	-	A	D	A	+	033
		1-4	5-6	7	8-10	11	12	13	14	15	16

- A Motor type
- B Motor size
- C Product code
- D Mounting arrangement code
- E Voltage and frequency code
- F Generation code
- G Variant codes

Explanation of the product code (C,D,E,F) :

Positions 1 to 4

M2JA = Totally enclosed fan cooled squirrel cage motor with cast iron frame proof three-phase Induction Motors for Hazardous Environments

Positions 5 and 6

IEC frame

07 = 71	13 = 132	25 = 250
08 = 80	16 = 160	28 = 280
09 = 90	18 = 180	31 = 315
10 = 100	20 = 200	35 = 355
11 = 112	22 = 225	

Positions 7

Speed (pole pairs)

- 1 = 2 poles
- 2 = 4 poles
- 3 = 6 poles
- 4 = 8 poles

Positions 8 to 10

Running number series

Positions 11

-(dash)

Code letters for supplementing the product code

A	B	D	E	F	H
380 VY 50 Hz	380 VΔ 50 Hz	380-420 VΔ 50 Hz 660-690 VY 50 Hz 440-480 VΔ 60 Hz	500 VΔ 50 Hz 575 VΔ 60 Hz	500 VY 50 Hz 575 VY 60 Hz	415 VΔ 50 Hz
S	T	U	X		
220-240 VΔ 50 Hz 380-420 VY 50 Hz 440-480 VY 60 Hz	660 VΔ 50 Hz	690 VΔ 50 Hz	Other rated Voltage, connection or frequency, max. 690 V	¹ 480 V not stamped on sizes 160 to 355	

Positions 12

Mounting arrangement

- A = Foot-mounted, top-mounted terminal box
- R = Foot-mounted, terminal box on RHS, seen from D-end
- L = Foot-mounted, terminal box on LHS, seen from D-end
- B = Flange-mounted, large flange
- C = Flange-mounted, small flange size (80-160)
- H = Foot-and flange-mounted

Positions 13

Voltage and frequency code

See tables on appropriate page

Positions 14

Generation code

A, B, C, ...

Positions 15

+(plus)

Positions 16

Variant codes

The product code must be, if need, followed by variant codes:
Please see page 6-13.

Flameproof motors Ex d IIC T4

Technical data for totally enclosed squirrel cage three phase motors
IP55 IC411; Insulation class F, temperature rise class B



400V 50Hz											
Output kW	Type designation M2JA	Product code 3GJA	Speed n r/min	Efficiency		Power factor cos ϕ	Current		Torque		
				Full load 100%	3/4 load 75%		I _N A	I _S /I _N	T _N Nm	T _S /T _N	T _{MAX} /T _N
3000 r/min=2 poles Basic design											
0.75	80M2A	081301-**C	2840	74.2	74.8	0.85	1.72	6.1	2.52	2.2	2.2
1.1	80M2B	081302-**C	2855	76.9	78.3	0.86	2.40	7.0	3.68	2.2	2.2
1.5	90S2A	091101-**C	2850	78.3	79.4	0.87	3.18	7.0	5.03	2.2	2.2
2.2	90L2A	091001-**C	2850	80.7	81.5	0.86	4.58	7.0	7.37	2.2	2.2
3	100L2A	101501-**C	2860	82.4	83.7	0.87	6.04	7.0	10.0	2.2	2.2
4	112M2A	111301-**C	2875	83.9	85.0	0.90	7.65	7.0	13.3	2.2	2.2
5.5	132S2A	131101-**C	2905	85.5	86.1	0.89	10.4	7.0	18.1	2.2	2.2
7.5	132S2B	131102-**C	2910	86.7	88.0	0.895	14.0	7.0	24.6	2.2	2.2
11	160M2A	161301-**C	2920	88.2	88.7	0.875	20.6	6.5	36.0	2.5	3.0
15	160M2B	161302-**C	2920	89.3	90.0	0.885	27.4	6.5	49.1	2.5	3.2
18.5	160L2A	161501-**C	2920	89.8	90.9	0.895	33.2	6.5	60.5	2.5	3.2
22	180M2A	181301-**C	2940	90.4	91.7	0.90	39.0	6.5	71.5	2.3	2.8
30	200L2A	201501-**C	2955	91.2	91	0.90	52.8	6.5	97.0	2.2	2.7
37	200L2B	201502-**C	2955	91.6	91.6	0.905	64.4	6.5	120	2.3	2.7
45	225M2A	221301-**C	2970	92.1	91.3	0.89	79.2	7.0	145	2.5	2.8
55	250M2A	251301-**C	2965	92.5	92.8	0.90	95.4	7.5	177	2.4	3.0
75	280S2A	281101-**C	2970	93.1	93.1	0.91	128	7.5	241	2.5	3.3
90	280M2A	281301-**C	2970	93.4	93.6	0.92	151	7.5	289	2.3	3.2
110	315S2A	311101-**C	2980	93.6	93.4	0.90	188	7.1	353	1.8	2.2
132	315M2A	311301-**C	2980	94.2	93.8	0.90	225	7.1	423	1.8	2.2
160	315L2A	311501-**C	2975	94.2	94.0	0.90	272	7.2	514	1.8	2.2
200	315L2B	311502-**C	2975	94.4	94.5	0.91	336	7.2	642	1.8	2.2
250	355M2A	351301-**C	2980	94.5	94.5	0.90	424	7.1	801	2.3	2.8
315	355L2A	351501-**C	2980	94.8	94.6	0.90	533	6.9	1009	2	2.8

400V 50Hz											
Output kW	Type designation M2JA	Product code 3GJA	Speed n r/min	Efficiency		Power factor cos ϕ	Current		Torque		
				Full load 100%	3/4 load 75%		I _N A	I _S /I _N	T _N Nm	T _S /T _N	T _{MAX} /T _N
1500 r/min=4 poles Basic design											
0.55	80M4A	082301-**C	1410	72.0	72.5	0.73	1.51	5.2	3.73	2.4	2.0
0.75	80M4B	082302-**C	1415	74.2	75.6	0.755	1.93	6.0	5.06	2.4	2.2
1.1	90S4A	092101-**C	1395	76.3	76.8	0.765	2.72	6.0	7.53	2.3	2.2
1.5	90L4A	092501-**C	1400	78.3	80.6	0.78	3.54	6.0	10.2	2.3	2.2
2.2	100L4A	102501-**C	1430	80.7	81.3	0.79	4.98	6.0	14.7	2.3	2.2
3	100L4B	102502-**C	1425	82.4	83.6	0.81	6.49	6.5	20.1	2.3	2.2
4	112M4A	112301-**C	1435	83.9	84.1	0.775	8.88	6.5	26.6	2.3	2.2
5.5	132S4A	132101-**C	1435	85.5	86.2	0.82	11.3	6.5	36.6	2.3	2.2
7.5	132M4A	132301-**C	1440	86.7	87.6	0.83	15.0	6.5	49.7	2.3	2.2
11	160M4A	162301-**C	1460	88.2	89.1	0.85	21.2	6.5	72.0	2.4	2.8
15	160L4A	162501-**C	1445	89.3	90.8	0.86	28.2	6.5	98.5	2.3	2.4
18.5	180M4A	182301-**C	1470	89.8	90.4	0.86	34.6	6.5	120	2.3	3.0
22	180L4A	182501-**C	1470	90.4	90.1	0.875	40.1	6.5	143	2.4	3.1
30	200L4A	202501-**C	1475	91.2	91.8	0.87	54.6	6.5	194	2.2	2.8
37	225S4A	222101-**C	1480	91.6	92.1	0.86	67.8	7.0	239	2.2	2.8
45	225M4A	222301-**C	1480	92.1	92.3	0.86	82.0	7.0	290	2.2	2.8
55	250M4A	252301-**C	1475	92.5	92.8	0.88	97.5	7.0	356	2.4	3.1
75	280S4A	282101-**C	1480	93.1	93.7	0.88	132	6.5	484	2.4	2.6
90	280M4A	282301-**C	1480	93.6	93.8	0.89	156	7.2	581	2.3	2.8
110	315S4A	312101-**C	1485	93.6	93.7	0.87	195	6.9	707	2.1	2.2
132	315M4A	312301-**C	1480	93.8	93.8	0.875	232	6.9	849	2.1	2.2
160	315L4A	322501-**C	1485	94.0	94.0	0.875	281	6.9	1029	2.1	2.2
200	315L4B	312502-**C	1480	94.2	94.2	0.875	350	6.9	1286	2.1	2.2
250	355M4A	352301-**C	1485	94.4	94.4	0.90	425	6.9	1602	2.1	2.6
315	355L4A	352501-**C	1485	94.8	94.8	0.90	533	7.0	2019	2.1	2.3

Flameproof motors Ex d IIC T4

Technical data for totally enclosed squirrel cage three phase motors
IP55 IC411; Insulation class F, temperature rise class B



400V 50Hz											
Output kW	Type designation M2JA	Product code 3GJA	Speed n r/min	Efficiency		Power factor cos ϕ	Current		Torque		
				Full load 100%	3/4 load 75%		I _N A	I _S /I _N	T _N Nm	T _S /T _N	T _{MAX} /T _N
1000 r/min=6 poles Basic design											
0.37	80M6A	083301-**C	930	63.5	63.9	0.66	1.27	5.0	3.80	1.9	1.8
0.55	80M6B	083302-**C	925	65.7	66.9	0.675	1.79	5.0	5.68	1.9	1.8
0.75	90S6A	093101-**C	920	71.5	72.6	0.72	2.10	5.0	7.79	2.0	2.2
1.1	90L6A	093501-**C	920	74.3	75.5	0.74	2.89	5.0	11.4	2.0	2.2
1.5	100L6A	103501-**C	940	76.4	76.2	0.74	3.83	5.5	15.2	2.0	2.2
2.2	112M6A	113301-**C	940	78.8	79.8	0.73	5.52	5.5	22.4	2.0	2.2
3	132S6A	133101-**C	945	80.7	81.6	0.77	6.97	6.5	30.3	2.0	2.2
4	132M6A	133301-**C	950	82.3	82.9	0.77	9.11	6.5	40.2	2.0	2.2
5.5	132M6B	133302-**C	950	83.9	85.8	0.78	12.1	6.5	55.3	2.0	2.2
7.5	160M6A	163301-**C	960	85.5	86.4	0.78	16.2	6.0	74.6	2.0	2.3
11	160L6A	163501-**C	970	87.1	88.0	0.78	23.4	6.0	108	2.2	2.3
15	180L6A	183501-**C	975	88.3	88.7	0.82	29.9	6.0	147	2.3	2.8
18.5	200L6A	203501-**C	980	89.2	90.2	0.82	36.5	6.0	180	2.2	2.8
22	200L6B	203502-**C	980	89.7	90.4	0.83	42.7	6.0	214	2.1	2.8
30	225M6A	223301-**C	985	90.7	91.1	0.815	58.6	6.6	291	2.2	2.8
37	250M6A	253301-**C	975	91.3	91.6	0.87	67.2	6.8	361	2.3	2.8
45	280S6A	283101-**C	985	91.8	92.0	0.875	80.9	6.2	439	2.3	2.4
55	280M6A	283301-**C	985	92.3	92.4	0.875	98.3	7.0	536	2.3	2.5
75	315S6A	313101-**C	985	93.0	93.2	0.86	135	7.4	723	2.0	2.0
90	315M6A	313301-**C	985	93.3	93.5	0.86	162	7.4	868	2.0	2.0
110	315L6A	313501-**C	985	93.6	93.8	0.875	194	6.8	1061	2.0	2.0
132	315L6B	313502-**C	985	93.8	94.0	0.875	232	6.8	1280	2.0	2.0
160	355M6A	353301-**C	990	94.0	94.2	0.88	279	6.8	1543	2.1	2.4
200	355M6B	353302-**C	990	94.2	94.3	0.88	348	6.7	1929	2.0	2.3
250	355L6A	353501-**C	990	94.4	94.5	0.88	434	6.7	2412	2.0	2.3

400V 50Hz											
Output kW	Type designation M2JA	Product code 3GJA	Speed n r/min	Efficiency		Power factor cos ϕ	Current		Torque		
				Full load 100%	3/4 load 75%		I _N A	I _S /I _N	T _N Nm	T _S /T _N	T _{MAX} /T _N
750 r/min=8 poles Basic design											
0.75	100L8A	104501-**C	690	68.5	68.6	0.64	2.47	5.0	10.4	1.8	2.0
1.1	100L8B	104502-**C	675	71.3	70.1	0.645	3.45	5.0	15.6	1.8	2.0
1.5	112M8A	114301-**C	695	74.2	74.6	0.675	4.32	5.0	20.6	1.8	2.0
2.2	132S8A	134101-**C	710	79.8	80.6	0.70	5.68	5.5	29.6	1.8	2.0
3	132M8A	134102-**C	710	80.0	80.4	0.75	7.22	5.5	40.4	1.8	2.0
4	160M8A	164301-**C	720	83.0	83.0	0.73	9.53	5.5	53.1	2.1	2.5
5.5	160M8B	164302-**C	720	84.5	94.6	0.74	12.7	5.5	73.0	2.1	2.5
7.5	160L8A	164501-**C	720	85.2	84.5	0.74	17.2	5.5	99.5	2.1	2.5
11	180L8A	184501-**C	730	87.5	86.8	0.77	23.6	5.4	144	2.0	2.8
15	200L8A	204501-**C	730	89.0	89.4	0.775	31.4	5.5	196	2.3	2.8
18.5	225S8A	224101-**C	735	89.5	88.6	0.73	40.9	5.5	240	2.1	2.8
22	225M8A	224301-**C	735	89.7	88.8	0.74	47.8	6.0	286	2.2	2.8
30	250M8A	254301-**C	730	91.3	89.3	0.79	60.0	6.5	390	2.3	2.6
37	280S8A	284101-**C	735	91.2	91.0	0.80	73.2	6.0	478	2.1	2.6
45	280M8A	284301-**C	735	92.0	90.6	0.80	88.2	6.0	581	2.1	2.7
55	315S8A	314101-**C	740	92.5	91.2	0.82	105	6.9	710	1.8	2.0
75	315M8A	314301-**C	740	93.0	91.9	0.82	142	7.0	968	1.8	2.0
90	315L8A	314501-**C	740	93.5	92.9	0.82	169	7.1	1161	1.8	2.0
110	315L8B	314502-**C	740	94.0	92.4	0.825	205	6.4	1420	1.8	2.0

Flameproof motors Ex d IIC T4

Technical data for totally enclosed squirrel cage three phase motors
IP55 IC411; Insulation class F, temperature rise class B



460V 60Hz													
Output kW	Type designation M2JA	Product code 3GJA	Speed r/min	Efficiency		Current		Torque			Moment of inertia J=GD ² /4 kgm ²	Weight kg	Sound pressure level Lp dB(A)
				Full load 100%	Power factor cosφ	I _N A	I _S I _N	T _N Nm	T _S T _N	T _{MAX} T _N			
3600 r/min=2 poles Basic design													
0.86	80M2A	081301-**C	3420	77.0	0.875	1.60	6.1	2.40	2.2	2.2	0.00091	30	60
1.27	80M2B	081302-**C	3430	78.5	0.87	2.33	7.0	3.54	2.2	2.2	0.00107	31	61
1.73	90S2A	091101-**C	3420	81.0	0.87	3.08	7.0	4.83	2.2	2.2	0.00135	34	64
2.53	90L2A	091501-**C	3440	81.5	0.86	4.53	7.0	7.02	2.2	2.2	0.00163	40	64
3.45	100L2A	101501-**C	3450	84.5	0.87	5.89	7.0	9.55	2.2	2.2	0.00402	46	68
4.60	112M2A	111301-**C	3475	86.0	0.91	7.38	7.0	12.6	2.2	2.2	0.00671	61	70
6.33	132S2A	131101-**C	3500	86.0	0.89	10.4	7.0	17.3	2.2	2.2	0.01241	79	73
8.6	132M2A	131102-**C	3510	87.5	0.895	13.8	7.0	23.4	2.2	2.2	0.01491	84	73
12.7	160M2A	161301-**C	3515	87.5	0.875	20.8	6.5	34.5	2.5	3.0	0.0436	149	75
17.3	160M2B	161302-**C	3515	89.5	0.895	27.1	6.5	47.0	2.5	3.2	0.0551	161	75
21.3	160L2A	161501-**C	3515	89.5	0.90	33.2	6.5	57.8	2.5	3.2	0.06549	185	75
25.3	180L2A	181301-**C	3540	89.5	0.90	39.4	6.5	68.3	2.3	2.8	0.08805	216	78
34.5	200L2A	201501-**C	3550	91.5	0.905	52.3	6.5	92.8	2.2	2.7	0.14821	312	84
42.6	200L2B	201502-**C	3550	91.7	0.91	64.1	6.5	115	2.3	2.7	0.16822	329	84
51.8	225M2A	221301-**C	3570	92.4	0.895	78.6	7.0	139	2.5	2.8	0.29345	406	84
63	250M2A	251301-**C	3565	92.4	0.90	95.1	7.5	169	2.4	3.0	0.3784	488	87
86	280S2A	281101-**C	3570	93.0	0.92	126	7.5	230	2.5	3.3	0.587	630	88
104	280M2A	281301-**C	3570	93.0	0.925	152	7.5	278	2.3	3.2	0.615	700	88
127	315S2A	311101-**C	3575	93.0	0.90	190	7.1	339	1.8	2.2	1.4083	1138	91
152	315M2A	311301-**C	3575	94.1	0.905	224	7.1	406	1.8	2.2	1.5584	1263	91
184	315L2A	311501-**C	3575	94.1	0.905	271	7.2	492	1.8	2.2	1.7256	1338	91
230	315L2B	311502-**C	3570	94.1	0.91	337	7.2	614	1.8	2.2	1.9405	1400	91
287.5	355M2A	351301-**C	3580	94.1	0.905	424	7.1	767	2.3	2.8	3.05	1798	92
362.5	355L2A	351501-**C	3580	94.1	0.905	534	6.9	967	2.0	2.8	3.6	2158	92

460V 60Hz													
Output kW	Type designation M2JA	Product code 3GJA	Speed r/min	Efficiency		Current		Torque			Moment of inertia J=GD ² /4 kgm ²	Weight kg	Sound pressure level Lp dB(A)
				Full load 100%	Power factor cosφ	I _N A	I _S I _N	T _N Nm	T _S T _N	T _{MAX} T _N			
1500 r/min=4 poles Basic design													
1800 r/min=4 poles													
0.63	80M4A	082301-**C	1695	73.5	0.73	1.47	5.2	3.55	2.4	2.0	0.00145	30	49
0.86	80M4B	082302-**C	1690	78.0	0.75	1.85	6.0	4.86	2.4	2.2	0.00174	31	49
1.27	90S4A	092101-**C	1695	79.0	0.765	2.64	6.0	7.16	2.3	2.2	0.00254	34	55
1.73	90L4A	092501-**C	1700	81.5	0.785	3.39	6.0	9.70	2.3	2.2	0.00317	41	55
2.53	100L4A	102501-**C	1730	83.0	0.795	4.81	6.0	14.0	2.3	2.2	0.00679	45	56
3.45	100L4B	102502-**C	1725	85.0	0.815	6.25	6.5	19.1	2.3	2.2	0.00862	52	56
4.60	112M4A	112301-**C	1735	87.0	0.785	8.45	6.5	25.3	2.3	2.2	0.01306	64	59
6.33	132S4A	132101-**C	1735	87.0	0.82	11.1	6.5	34.8	2.3	2.2	0.02673	81	62
8.6	132M4A	132301-**C	1735	87.5	0.83	14.9	6.5	47.3	2.3	2.2	0.03432	94	62
12.7	160M4A	162301-**C	1755	88.5	0.87	20.7	6.5	69.1	2.4	2.8	0.06543	152	69
17.3	160L4A	162501-**C	1750	90.5	0.88	27.3	6.5	94.4	2.3	2.4	0.09349	181	69
21.3	180M4A	182301-**C	1770	91.0	0.865	34.0	6.5	115	2.3	3.0	0.16049	214	69
25.3	180L4A	182501-**C	1770	91.0	0.88	39.7	6.5	137	2.4	3.1	0.18046	232	69
34.5	200L4A	202501-**C	1775	92.4	0.875	53.6	6.5	186	2.2	2.8	0.2819	312	74
42.6	225S4A	222101-**C	1780	93.0	0.87	66.1	7.0	229	2.2	2.8	0.37	358	76
51.8	225M4A	222301-**C	1780	93.0	0.86	81.3	7.0	278	2.2	2.8	0.42	396	76
63	250M4A	252301-**C	1775	93.0	0.885	96.1	7.0	339	2.4	3.0	0.78	563	79
86	280S4A	282101-**C	1780	93.2	0.885	131	6.5	461	2.4	2.6	1.10	668	81
104	280M4A	282301-**C	1780	93.5	0.895	156	7.2	558	2.3	2.8	1.35	740	81
127	315S4A	312101-**C	1780	93.5	0.875	195	6.9	681	2.1	2.2	2.8596	1163	83
152	315M4A	312301-**C	1780	94.5	0.88	229	6.9	816	2.1	2.2	3.1848	1288	83
184	315L4A	312501-**C	1780	94.5	0.875	279	6.9	987	2.1	2.2	3.6765	1313	89
230	315L4B	312502-**C	1780	94.5	0.885	345	6.9	1234	2.1	2.2	4.2516	1375	89
287.5	355M4A	352301-**C	1785	94.5	0.905	422	6.9	1538	2.1	2.6	6.77	1933	90
362.5	355L4A	352501-**C	1785	94.5	0.905	532	7.0	1943	2.1	2.3	8.20	2275	90

Flameproof motors Ex d IIC T4

Technical data for totally enclosed squirrel cage three phase motors
IP55 IC411; Insulation class F, temperature rise class B



460V 60Hz													
Output kW	Type designation M2JA	Product code 3GJA	Speed r/min	Efficiency		Current		Torque			Moment of inertia J=GD ² /4 kgm ²	Weight kg	Sound pressure level Lp dB(A)
				Full load 100%	Power factor cosφ	I _N A	I _S I _N	T _N Nm	T _S T _N	T _{MAX} T _N			
1200 r/min=6 poles Basic design													
0.43	80M6A	083301-**C	1105	66.3	0.66	1.23	5.0	3.72	1.9	1.9	0.00159	31	48
0.63	80M6B	083302-**C	1115	68.0	0.665	1.75	5.0	5.40	1.9	1.9	0.00196	32	48
0.86	90S6A	093101-**C	1115	73.0	0.72	2.05	5.0	7.37	2.0	2.2	0.00292	34	51
1.27	90L6A	093501-**C	1110	75.0	0.72	2.95	5.0	10.9	2.0	2.2	0.00379	41	51
1.73	100L6A	103501-**C	1135	77.0	0.745	3.79	5.5	14.6	2.0	2.2	0.00999	45	54
2.53	112M6A	113301-**C	1140	78.5	0.735	5.50	5.5	21.2	2.0	2.2	0.01559	59	57
3.45	132S6A	133101-**C	1145	83.5	0.77	6.73	6.5	28.8	2.0	2.2	0.03116	76	59
4.60	132M6A	133301-**C	1150	85.0	0.77	8.82	6.5	38.2	2.0	2.2	0.04074	86	59
6.33	132M6B	133302-**C	1150	85.0	0.78	12.0	6.58	52.6	2.0	2.2	0.05332	96	59
8.6	160M6A	163301-**C	1165	86.0	0.78	16.1	6.0	70.5	2.0	2.3	0.09231	153	64
12.7	160L6A	163501-**C	1165	89.0	0.785	22.8	6.0	104	2.2	2.3	0.12970	181	65
17.3	180L6A	183501-**C	1175	90.2	0.83	29.0	6.0	141	2.3	2.8	0.2418	225	66
21.3	200L6A	203501-**C	1175	91.0	0.83	35.4	6.0	173	2.2	2.8	0.34174	294	67
25.3	200L6B	203502-**C	1175	91.0	0.84	41.5	6.0	206	2.1	2.8	0.46837	308	67
34.5	225M6A	223301-**C	1185	91.7	0.825	57.2	6.6	278	2.2	2.8	0.62691	385	69
42.6	250M6A	253301-**C	1175	91.7	0.88	66.3	6.8	345	2.3	2.8	0.97	478	71
51.8	280S6A	283101-**C	1185	92.1	0.88	80.2	6.2	419	2.3	2.4	1.25	603	72
63	280M6A	283301-**C	1185	92.1	0.88	97.6	7.0	510	2.3	2.5	1.485	665	73
86	315S6A	313101-**C	1185	93.0	0.865	134	7.4	693	2.0	2.0	3.1942	1150	78
104	315M6A	313301-**C	1185	94.1	0.865	160	7.4	838	2.0	2.0	3.723	1263	73
127	315L6A	313501-**C	1185	94.1	0.875	194	6.8	1024	2.0	2.0	4.2564	1325	73
152	315L6B	313502-**C	1185	94.1	0.88	230	6.8	1225	2.0	2.0	5.1577	1400	73
184	355M6A	353301-**C	1190	94.1	0.88	279	6.8	1477	2.1	2.4	7.8	1700	78
230	355M6B	353302-**C	1190	94.1	0.885	347	6.7	1846	2.0	2.3	9.1	1939	78
287.5	355L6A	353501-**C	1190	94.1	0.885	433	6.7	2307	2.0	2.3	11.4	2571	78

460V 60Hz													
Output kW	Type designation M2JA	Product code 3GJA	Speed r/min	Efficiency		Current		Torque			Moment of inertia J=GD ² /4 kgm ²	Weight kg	Sound pressure level Lp dB(A)
				Full load 100%	Power factor cosφ	I _N A	I _S I _N	T _N Nm	T _S T _N	T _{MAX} T _N			
900 r/min=8 poles Basic design													
0.86	100L8A	104501-**C	840	72.0	0.64	2.34	5.0	9.78	1.8	2.0	0.00971	44	56
1.27	100L8B	104502-**C	830	72.8	0.645	3.39	5.0	14.6	1.8	2.0	0.01186	50	56
1.73	112M8A	114301-**C	845	76.4	0.675	4.21	5.0	19.6	1.8	2.0	0.1559	61	58
2.53	132S8A	134101-**C	860	80.7	0.73	5.39	5.5	28.1	1.8	2.0	0.03625	77	58
3.45	132M8A	134301-**C	855	81.8	0.755	7.01	5.5	38.5	1.8	2.0	0.04141	85	59
4.60	160M8A	164301-**C	865	84.0	0.75	9.16	5.5	50.8	2.1	2.5	0.0676	139	61
6.33	160M8A	164302-**C	865	84.9	0.76	12.3	5.5	69.9	2.1	2.5	0.09524	151	61
8.6	160L8A	164501-**C	865	85.2	0.77	16.5	5.5	94.9	2.1	2.5	0.12122	177	61
12.7	180L8A	184501-**C	880	88.8	0.775	23.2	5.4	138	2.0	2.8	0.23645	222	64
17.3	200L8A	204501-**C	880	89.7	0.785	30.8	5.5	188	2.3	2.8	0.37103	308	66
21.3	225S8A	224101-**C	885	90.2	0.745	39.8	5.5	230	2.1	2.8	0.53287	341	68
25.3	225M8A	224301-**C	885	90.4	0.75	46.8	6.0	273	2.2	2.8	0.65825	383	68
34.5	250M8A	254301-**C	880	91.6	0.80	59.4	6.5	374	2.3	2.6	0.975	490	70
42.6	280M8A	284101-**C	885	91.2	0.805	72.8	6.0	460	2.1	2.6	1.25	610	71
51.8	280S8A	284301-**C	885	92.0	0.805	87.8	6.0	559	2.1	2.7	1.485	685	71
63	315S8A	314101-**C	885	92.6	0.825	104	6.9	676	1.8	2.0	3.6842	1163	68
86	315M8A	314301-**C	890	93.1	0.825	141	7.0	923	1.8	2.0	4.9591	1263	71
104	315L8A	314501-**C	890	93.7	0.825	169	7.1	1116	1.8	2.0	5.8205	1338	71
127	315L8A	314502-**C	885	94.2	0.83	204	6.4	1363	1.8	2.0	6.7537	1425	71

Dimension Drawing

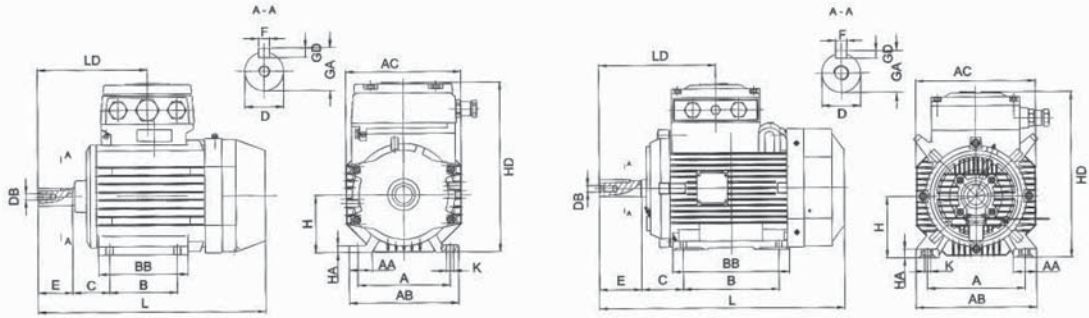

M2JA80-132

M2JA160-355

IMB3 (IM1001)

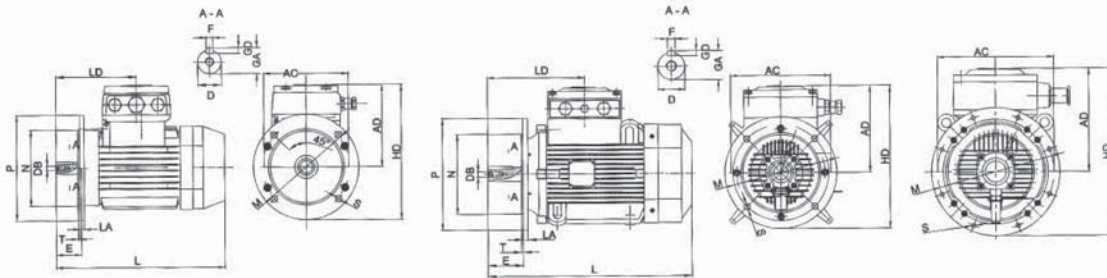

M2JA80-132

M2JA160-200

M2JA225-355

IMB5 (IM3001)

Type	Poles	A	AA	AB	AC	B	BB	C	D	E	F	GA	GD	H	HA	HD	K	L	LD	AD	LA	M	N	P	S	R	DB	EG
80M	2-8	125	35	160	165	100	135	50	19	40	6	21.5	6	80	12	260	10	340	155	180	12	165	130	200	12	3.5	M6	16
90S	2-8	140	35	175	180	100	140	56	24	50	8	27	7	90	12	275	10	355	165	181	12	165	130	200	12	3.5	M8	19
90L	2-8	140	35	175	180	125	165	56	24	50	8	27	7	90	12	275	10	380	165	181	12	165	130	200	12	3.5	M8	19
100L	2-8	160	40	200	205	140	180	63	28	60	8	31	7	100	14	300	12	450	190	195	11	215	180	250	15	4	M10	22
112M	2-8	190	50	235	225	140	190	70	28	60	8	31	7	112	15	320	12	490	205	202	11	215	180	250	15	4	M10	22
132S	2-8	216	55	270	265	140	205	89	38	80	10	41	8	132	18	360	12	485	205	220	12	265	230	300	15	4	M12	28
132M	2-8	216	55	270	265	178	240	89	38	80	10	41	8	132	18	360	12	520	225	220	12	265	230	300	15	4	M12	28
160M	2-8	254	60	325	330	210	270	108	42	110	12	45	8	160	22	450	15	650	305	285	15	300	250	350	19	5	M16	36
160L	2-8	254	60	325	330	254	315	108	42	110	12	45	8	160	22	450	15	690	305	285	15	300	250	350	19	5	M16	36
180M	2-4	279	70	355	355	241	315	121	48	110	14	51.5	9	180	22	480	15	725	315	295	18	300	250	350	19	5	M16	36
180L	4-8	279	70	355	355	279	355	121	48	110	14	51.5	9	180	22	480	15	765	315	295	18	300	250	350	19	5	M16	36
200L	2-8	318	70	390	395	305	395	133	55	110	16	59	10	200	25	610	19	815	365	404	20	350	300	400	19	5	M20	39
225S	4-8	356	75	435	440	286	380	149	60	140	18	64	11	225	28	650	19	845	395	421	20	400	350	450	19	5	M20	39
225M	2	356	75	435	440	311	405	149	55	110	16	59	10	225	28	650	19	840	365	421	20	400	350	450	19	5	M20	39
225M	4-8	356	75	435	440	311	405	149	60	140	18	64	11	225	28	650	19	870	395	421	20	400	350	450	19	5	M20	39
250M	2	406	80	490	515	349	475	168	60	140	18	64	11	250	30	700	24	970	420	447	22	500	450	550	19	5	M20	39
250M	4-8	406	80	490	515	349	475	168	65	140	18	69	11	250	30	700	24	970	420	447	22	500	450	550	19	5	M20	39
280S	2	457	85	555	585	368	190	190	65	140	18	69	11	280	35	750	24	1030	450	470	22	500	450	550	19	5	M20	39
280S	4-8	457	85	555	585	368	490	190	75	140	20	79.5	12	280	35	750	24	1030	450	470	22	500	450	550	19	5	M20	39
280M	2	457	85	555	585	419	540	190	65	140	18	69	11	280	35	750	24	1080	450	470	22	500	450	550	19	5	M20	39
280M	4-8	508	85	555	585	419	540	190	75	140	20	79.5	12	280	35	750	24	1080	450	470	22	500	450	550	19	5	M20	39
315S	2	508	120	640	630	406	575	216	65	140	18	69	11	315	45	1010	28	1240	440	685	24	600	550	660	24	6	M20	42
315S	4-8	508	120	640	630	406	575	216	80	170	22	85	14	315	45	1010	28	1240	470	685	24	600	550	660	24	6	M20	42
315M	2	508	120	640	630	457	685	216	65	140	18	69	11	315	45	1010	28	1380	440	685	24	600	550	660	24	6	M20	42
315M	4-8	508	120	640	630	457	685	216	80	170	22	85	14	315	45	1010	28	1380	470	685	24	600	550	660	24	6	M20	42
315L	2	508	120	640	630	508	685	216	65	140	18	69	11	315	45	1010	28	1380	440	685	24	600	550	660	24	6	M20	42
315L	4-8	508	120	640	630	508	685	216	80	170	22	85	14	315	45	1010	28	1380	470	685	24	600	550	660	24	6	M20	42
355M	2	610	120	735	710	560	755	254	70	140	20	74.5	12	355	52	1080	35	1550	470	695	25	600	680	800	24	6	M20	42
355M	4-6	610	120	735	710	560	755	254	100	210	28	106	16	355	52	1080	35	1620	540	695	25	600	680	800	24	6	M24	47
355L	2	610	120	735	710	630	755	254	70	140	20	74.5	12	355	52	1080	35	1550	470	695	25	600	680	800	24	6	M20	42
355L	4-6	610	120	735	710	630	755	254	100	210	28	106	16	355	52	1080	35	1620	540	695	25	600	680	800	24	6	M24	47

Dimension Drawing

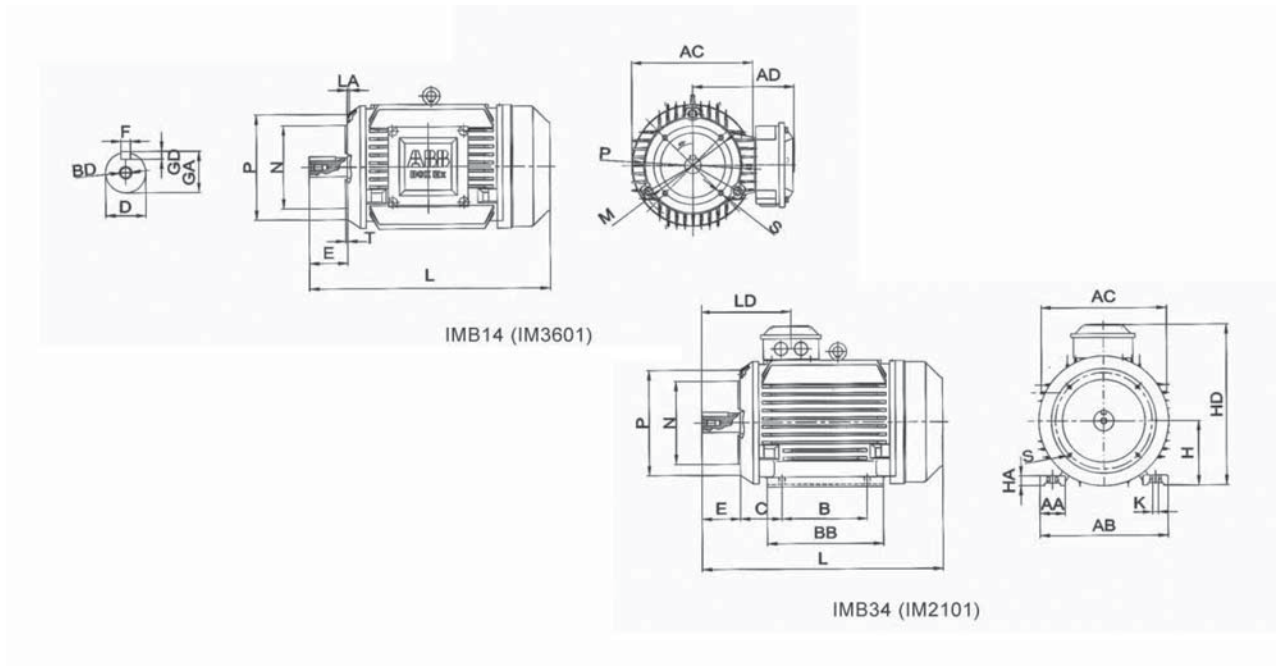

Type	Poles	A	AA	AB	AC	B	BB	C	D	E	F	GA	GD	H	HA	HD	K	L	LD	AD	LA	HE	DB	EG
80M	2-8	125	35	160	165	100	135	50	19	40	6	21.5	6	80	12	260	10	340	155	145	9	200	M6	16
90S	2-8	140	35	175	180	100	140	56	24	50	8	27	7	90	12	275	10	355	165	150	10	200	M8	19
90L	2-8	140	35	175	180	125	165	56	24	50	8	27	7	90	12	275	10	380	165	150	10	200	M8	19
100L	2-8	160	40	200	205	140	180	63	28	60	8	31	7	100	14	300	12	450	190	175	11	270	M10	22
112M	2-8	190	50	235	225	140	190	70	28	60	8	31	7	112	15	320	12	490	205	185	11	278	M10	22
132S	2-8	216	55	270	265	140	205	89	38	80	10	41	8	132	18	360	12	485	205	220	15	320	M12	28
132M	2-8	216	55	270	265	178	240	89	38	80	10	41	8	132	18	360	12	520	225	220	15	320	M12	28
160M	2-8	254	60	325	330	210	270	108	42	110	12	45	8	160	22	450	15	650	305	285	20	400	M16	36
160L	2-8	254	60	325	330	254	315	108	42	110	12	45	8	160	22	450	15	690	305	285	20	400	M16	36

Type	Poles	size	P	M	N	S	T
80M	2-8	C120	120	100	80	M6	3
80M	2-8	C160	160	130	110	M8	3.5
90S	2-8	C140	140	115	95	M8	3
90S	2-8	C160	160	130	110	M8	3.5
90L	2-8	C140	140	115	95	M8	3.
90L	2-8	C160	160	130	110	M8	3.5
100L	2-8	C160	160	130	110	M8	3.5
100L	2-8	C200	200	165	130	M10	3.5
112M	2-8	C160	160	130	110	M8	3.5
112M	2-8	C200	200	165	130	M10	3.5
132S	2-8	C200	200	165	130	M10	3.5
132M	2-8	C200	200	165	130	M10	3.5
160M	2-8	C250	250	215	180	M12	4
160L	2-8	C250	250	215	180	M12	4

M2JA Motor's Variant Code

Code	Variant	Frame Size												
		80	90	100	112	132	160	180	200	225	250	280	315	355
Administration														
531	Sea freight packing	NA	NA	NA	NA	NA	P	P	P	P	P	P	P	P
Balancing														
423	Balanced without key.	P	P	P	P	P	P	P	P	P	P	P	P	P
424	Full key balancing.	P	P	P	P	P	P	P	P	P	P	P	P	P
Bearings and Lubrication														
039	Cold resistant grease.	P	P	P	P	P	P	P	P	P	P	P	P	P
040	Heat resistant grease.	P	P	P	P	P	P	P	P	P	P	P	P	P
041	Bearings regreasable via grease nipples.	NA	NA	NA	NA	NA	S	S	S	S	S	S	S	S
043	SPM compatible nipples for vibration measurement.	NA	NA	NA	NA	NA	P	P	P	P	P	P	P	P
195	Bearings greased for life.	S	S	S	S	S	NA	NA	NA	NA	NA	NA	NA	NA
798	Stainless steel grease nipples.	NA	NA	NA	NA	NA	P	P	P	P	P	P	P	P
Branch standard designs														
168	Primer paint only.	P	P	P	P	P	P	P	P	P	P	P	P	P
396	Motor designed for ambient temperature -20°C~-40°C, with space heaters(code 450/451 must be added).	P	P	P	P	P	P	P	P	P	P	P	P	P
425	Corrosion protected stator and rotor core.	P	P	P	P	P	P	P	P	P	P	P	P	P
Cooling system														
068	Light alloy metal fan.	P	P	P	P	P	S	S	S	S	S	S	S	S
Documentation														
141	Binding dimension drawing.	P	P	P	P	P	P	P	P	P	P	P	P	P
Earthing Bolt														
067	External earthing bolt.	S	S	S	S	S	S	S	S	S	S	S	S	S
Heating elements														
450	Heating elements,100-120V	P	P	P	P	P	P	P	P	P	P	P	P	P
451	Heating elements,200-240V	P	P	P	P	P	P	P	P	P	P	P	P	P
Mounting arrangements														
008	IM2101 foot/flange mounted, IEC flange,from IM1001 (B34 from B3)	P	P	P	P	P	P	NA	NA	NA	NA	NA	NA	NA
009	IM2001 foot/flange mounted, IEC flange,from IM1001 (B35 from B3)	P	P	P	P	P	P	P	P	P	P	P	P	P
047	IM3601 flange mounted, IEC flange,from IM3001 (B14 from B5)	P	P	P	P	P	P	NA	NA	NA	NA	NA	NA	NA
066 ¹⁾	Modified for specified mounting position differing from IM B3(1001),IM B5 (3001.),B14(3601) , IM B35 (2001)&IM B34)	P	P	P	P	P	P	P	P	P	R	R	R	R
999	B14 big flange	P	P	P	P	NA	NA	NA	NA	NA	NA	NA	NA	NA

note:

1)Mounting arrangements:B6, B7, B8, V1, V15, V3, V35, V5, V6, (Only V1, V15 for H250 and above)

S=Included as standard
R=On request
NA=Not applicable
P=Applicable

M2JA Motor's Variant Code

Code	Variant	Frame Size												
		80	90	100	112	132	160	180	200	225	250	280	315	355
Painting														
114	Special paint colour, standard grade.	R	R	R	R	R	R	R	R	R	R	R	R	R
106	Paint thickness=80µm.	S	S	S	S	S	S	S	S	S	S	S	S	S
109	Paint thickness=120µm.	R	R	R	R	R	R	R	R	R	R	R	R	R
110	Paint thickness=160µm.	R	R	R	R	R	R	R	R	R	R	R	R	R
Protection														
005	Metal protective roof, vertical motor, shaft down.	P	P	P	P	P	P	P	P	P	P	P	P	P
072	Radial seal at D-end.	S	S	S	S	S	S	S	S	S	S	S	S	S
Rating & instnction plates														
002	Restamping voltage, frequency and output, continuous duty.	R	R	R	R	R	R	R	R	R	R	R	R	R
135	Mounting of additional identification plate, stainless.	P	P	P	P	P	P	P	P	P	P	P	P	P
139	Additional identification plate, stainless	P	P	P	P	P	P	P	P	P	P	P	P	P
Shaft & rotor														
069	Two shaft extension as per basic catalogue.	R	R	R	R	R	R	NA	NA	NA	NA	NA	NA	NA
070	Special shaft extension at D-end, standard shaft material.	R	R	R	R	R	R	R	R	R	R	R	R	R
164	Shaft extension with closed key-way.	P	P	P	P	P	P	P	P	P	P	P	P	P
165	Shaft extension with open key-way.	S	S	S	S	S	S	S	S	S	S	S	S	S
Standards and Regulations														
115	Painting system C4M acc. To ISO 12944-5:2007.	R	R	R	R	R	R	R	R	R	R	R	R	R
754	Painting system C5M acc. To ISO 12944-5:2007.	R	R	R	R	R	R	R	R	R	R	R	R	R
Stator winding temperature sensors														
435	PTC-thermistors(3 in series), 130°C in stator winding.	P	P	P	P	P	P	P	P	P	P	P	P	P
436	PTC-thermistors(3 in series), 150°C in stator winding.	P	P	P	P	P	P	P	P	P	P	P	P	P
439	PTC-thermistors(2x3 in series), 150°C, in stator winding.	P	P	P	P	P	P	P	P	P	P	P	P	P
440	PTC-thermistors(3 in series 110°C & 3 in series 130°C), in stator winding.	P	P	P	P	P	P	P	P	P	P	P	P	P
441	PTC-thermistors(3 in series 130°C & 3 in series 150°C), in stator winding.	P	P	P	P	P	P	P	P	P	P	P	P	P
445	PT100 2-wire in stator winding, 1 per phase.	P	P	P	P	P	P	P	P	P	P	P	P	P
502	PT100 3-wire in stator winding, 1 per phase.	NA	NA	NA	NA	NA	P	P	P	P	P	P	P	P
503	PT100 3-wire in stator winding, 2 per phase.	NA	NA	NA	NA	NA	NA	NA	NA	NA	P	P	P	P

S=Included as standard
R=On request
NA=Not applicable
P=Applicable

M2JA Motor's Variant Code

Code	Variant	Frame Size												
		80	90	100	112	132	160	180	200	225	250	280	315	355
Terminal box														
022	Cable entry LHS(see from D-end).	P	P	P	P	P	P	P	P	P	P	P	P	P
400	4x90 degr turnable terminal box.	S	S	S	S	S	S	S	S	S	S	S	S	S
468	Cable entry from D-end.	R	R	R	R	R	R	R	R	R	R	R	R	R
469	Cable entry from N-end.	R	R	R	R	R	R	R	R	R	R	R	R	R
230	Standard mental cable glands.	S	S	S	S	S	NA	NA	NA	NA	NA	NA	NA	NA
731	Two standard metal cable glands.	R	R	R	R	R	S	S	S	S	S	S	S	S
738	Prepared for metric cable glands.	P	P	P	P	P	P	P	P	P	P	P	P	P
999	Standard stainless steel cable gland,ATEX Exd IIC	P	P	P	P	P	P	P	P	P	P	P	P	P
999	Standard stainless steel cable gland,OSXP Exd IIC	P	P	P	P	P	P	P	P	P	P	P	P	P
Testing														
145	Type test report from a catalogue motor,400V 50HZ.	P	P	P	P	P	P	P	P	P	P	P	P	P
146	Type test with report for one motor from special delivery batch.	P	P	P	P	P	P	P	P	P	P	P	P	P
147	Type test with report for motor from special delivery bach, customer witnessed.	P	P	P	P	P	P	P	P	P	P	P	P	P
148	Routine test report.	P	P	P	P	P	P	P	P	P	P	P	P	P
221	Tyoe test and multi-point load test with report for one motor from specific delivery batch.	P	P	P	P	P	P	P	P	P	P	P	P	P
222	Tyoe test and multi-point load test with report for one motor from specific delivery batch.	P	P	P	P	P	P	P	P	P	P	P	P	P
Variable speed drives														
760	Vibration level test.	P	P	P	P	P	P	P	P	P	P	P	P	P
762	Noise level test for one motor from specific delivery batch.	P	P	P	P	P	P	P	P	P	P	P	P	P

S=Included as standard
R=On request
NA=Not applicable
P=Applicable

M2000 Flame proof motors – totally enclosed squirrel cage three phase motors

Lubrication :

Motor sizes 80-132 are fitted with bearing that are regreased for life. For size 160-355 are equipped with bearing that are regreasable via grease nipples.

Insulation :

Phase insulation and generous electrical Dimensioning give the motor a high overload capacity. (Suitable for frequency converter drive)

Endshields, flanges :

The endshield of Ex d and different variants of flanges are of cast iron.

Bearings :

The motor size 80-90 are fitted with enclosed 2RS1 bearing as standard. The motor sizes 100-132 are fitted with enclosed DDU C3 bearing as standard. Sizes 160-355 have regreasable bearings as standard. Modern design secure high load capacity run.

Terminal box :

The spacious terminal box of cast iron makes the motor quick and easy to connect. The terminal box of motor size 80-355 can be turned 4x90 degrees. As standard the terminal box is on top of the motor. (terminal box side mounted is not acceptable).

Rotor winding :

The rotor winding is made of pressure diecast aluminium, a design that provides high starting capacity and low noise level.

Low noise level :

The high efficiency of the motor means that a smaller, quieter fan can be used.

Corrosion protection :

Effective corrosion protection means that the motor can be used in all environments.

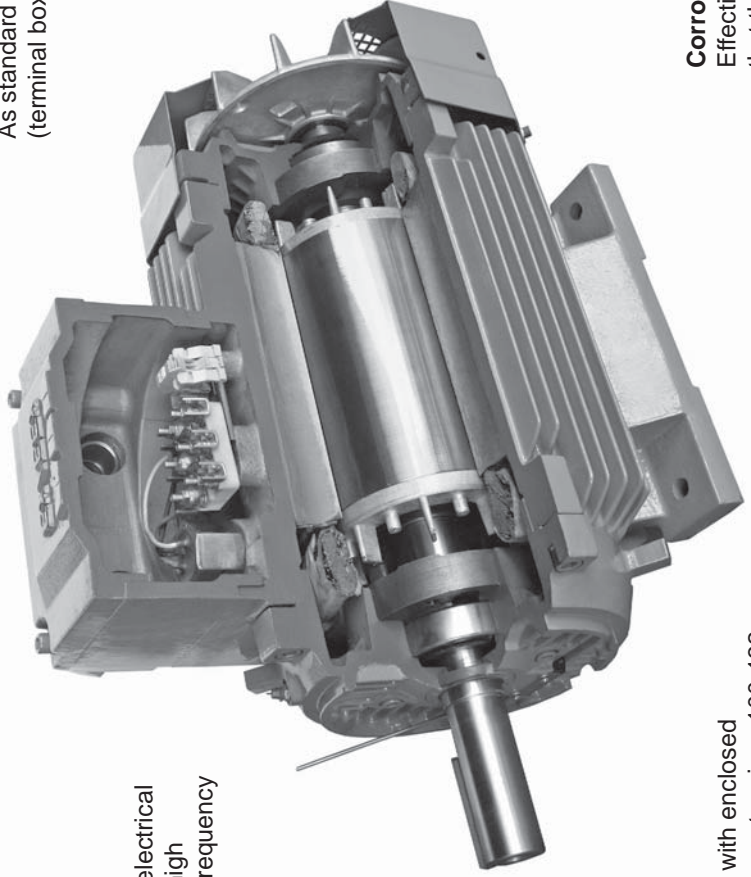

Visit our web site www.abb.com/motors&generators

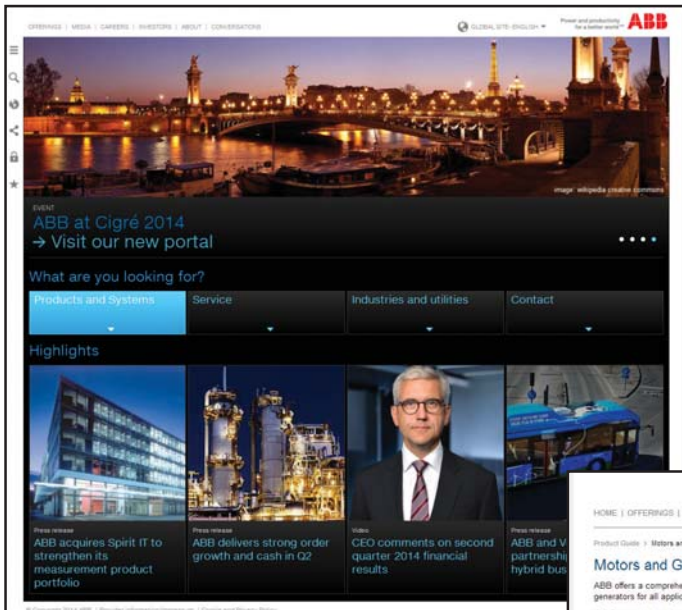

1. go to www.abb.com
- > select Product and System
- > select Motors and Generators
- > select Low voltage motors

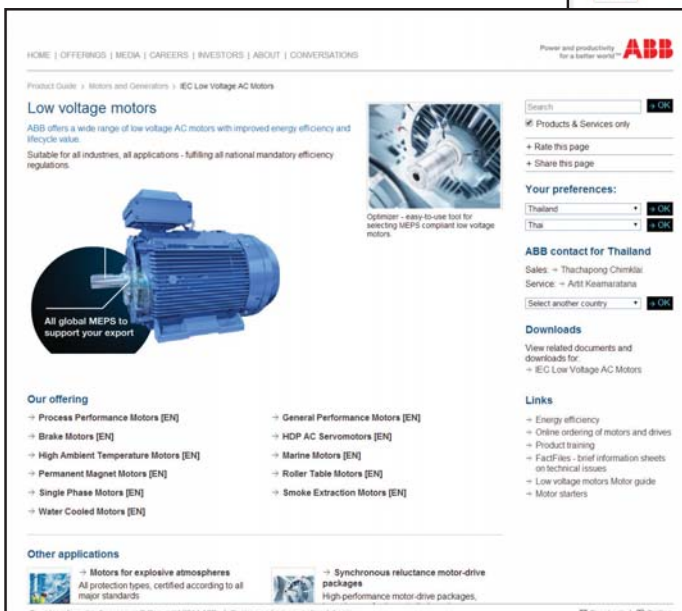
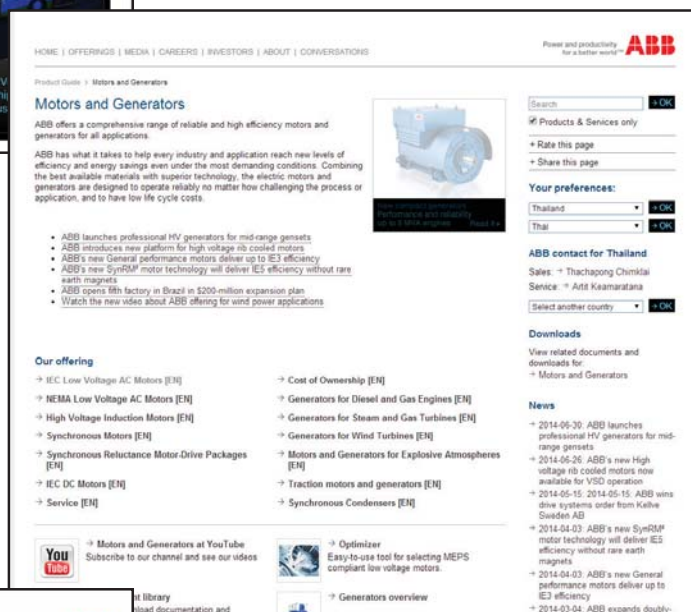

Contact us

ABB LIMITED

161/1 SG Tower, 1st - 4th Floor, Soi Mahadlekluang 3,
Rajdamri road, Lumpini, Pathumwan
Bangkok 10330, Thailand
Tel: +66 2665 1000
Fax: +66 2665 1042

www.abb.com/motors&generators